

## Plastic Surgery Instruments



Email : [info@chaghitraders.com](mailto:info@chaghitraders.com)



Website: [www.chaghitraders.com](http://www.chaghitraders.com)



Mobile & Whatsapp: 0092 333 1277 676



Address: New Miana Pura West, Near Islamic Road, Eid Gah Chowk, Sialkot , 51310, Pakistan.



## Scissors

- Gorney**
- CT-108-21518 18.0 cm, curved, serrated, TC
  - CT-108-21420 20.0 cm, straight, serrated, TC
  - CT-108-21520 20.0 cm, curved, serrated, TC
  - CT-108-21523 23.0 cm, curved, serrated, TC

- Gorney**
- CT-108-21220 20.0 cm, straight, serrated
  - CT-108-21320 20.0 cm, curved, serrated

- Freeman Gorney**
- CT-108-21620 20.0 cm, straight, TC
  - CT-108-21720 20.0 cm, curved, TC

- Freeman**
- CT-108-21918 18.0 cm, straight, TC
  - CT-108-22018 18.0 cm, curved, TC



## Scissors

### Aston-Face

- CT-108-24516** 17.0 cm, curved
- CT-108-24520** 20.0 cm, curved



### Rees

- CT-108-22417** 17.0 cm, straight, serrated, TC
- CT-108-22517** 17.0 cm, curved, serrated, TC
- CT-108-22419** 20.0 cm, straight, serrated, TC
- CT-108-22519** 20.0 cm, curved, serrated, TC



### Kaye

- CT-108-23315** 15.0 cm, curved, serrated, TC
- CT-108-23323** 23.0 cm, curved, serrated, TC



### Kaye

- CT-108-23312** 11.5 cm, curved, serrated, TC



**Scissors**

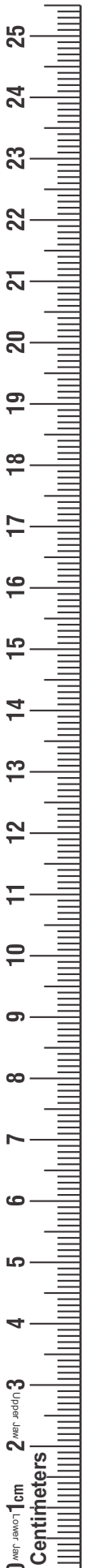

**Freeman (Kaye)**

- CT-108-21818** 18.0 cm, curved, serrated, TC
- CT-108-21820** 20.0 cm, curved, serrated, TC



**Davis**

- CT-108-24018** 18.0 cm, curved, serrated, sharp/sharp, TC



**Castanares**

- CT-108-24816** 16.5 cm, straight, TC



**Goldman Fox**

- CT-108-82313** 13.0 cm, curved, serrated, TC



## Scissors

### Par Style

very delicate

**CT-108-20911**

11.5 cm, curved, TC

**CT-108-20914**

14.5 cm, curved, TC

for serrated blades please add "WS"



### Stevens Tenotomy

**CT-108-36051**

11.5 cm, straight, TC

**CT-108-36151**

11.5 cm, curved, TC



### Stevens Tenotomy

**CT-108-36011**

11.0 cm, straight, sharp/sharp

**CT-108-36111**

11.0 cm, curved, sharp/sharp

**CT-108-36211**

11.0 cm, straight, blunt/blunt

**CT-108-36311**

11.0 cm, curved, blunt/blunt



### Devine

fine dissecting scissors  
with sharp tips,

**CT-108-21011**

11.0 cm, curved, TC



## Scissors

- Kilner**
- CT-108-31212** 12.0 cm, straight, TC
  - CT-108-31412** 12.0 cm, curved, TC
  - D-5851BLHM** 12.0 cm, curved  
1 blade TC  
1 blade serrated



- Strabismus**
- CT-108-37411** 11.0 cm, straight, TC
  - CT-108-37511** 11.0 cm, curved, TC
  - CT-107-37411** 11.0 cm, straight, supercut
  - CT-107-37511** 11.0 cm, curved, supercut
- for serrated blades please add "WS"



- Iris**
- CT-108-34211** 11.5 cm, round, straight, sharp/sharp
  - CT-108-34311** 11.5 cm, round, curved, sharp/sharp
  - CT-108-34251** 11.5 cm, round, straight, sharp/sharp, TC
  - CT-108-34351** 11.5 cm, round, curved, sharp/sharp, TC
- for serrated blades please add "WS"



- Iris**
- CT-108-34011** 11.5 cm, square, straight, sharp/sharp
  - CT-108-34111** 11.5 cm, square, curved, sharp/sharp
  - CT-108-34411** 11.5 cm, square, straight, sharp/sharp, TC
  - CT-108-34511** 11.5 cm, square, curved, sharp/sharp, TC
- for serrated blades please add "WS"



## Scissors

### Joseph

- CT-108-30414** 14.0 cm, straight, sharp/sharp
- CT-108-30514** 14.0 cm, curved, sharp/sharp
- CT-108-30454** 14.0 cm, straight, sharp/sharp, TC
- CT-108-30554** 14.0 cm, curved, sharp/sharp, TC

### Locklin

- CT-108-53916** 16.0 cm, straight, angled, sharp/sharp, TC

### Shea

- CT-108-30612** 12.0 cm, sharp, fine, curved



**Scissors**

**Heymann**  
18.0 cm, angled to side  
**CT-108-40118**

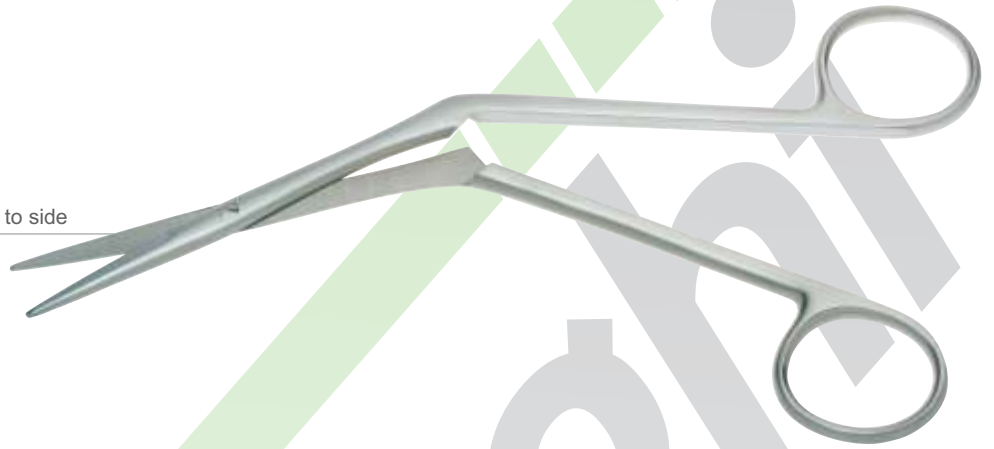

**Knight**  
18.0 cm, angled to side, serrated,  
delicate blades, TC  
**CT-108-39518**



**Wilmer Converse**  
10.5 cm, angled up  
**CT-108-35010**





## Scissors

**CT-108-40213** **Fomon**  
13.5 cm, lower lateral scissor,  
strongly curved

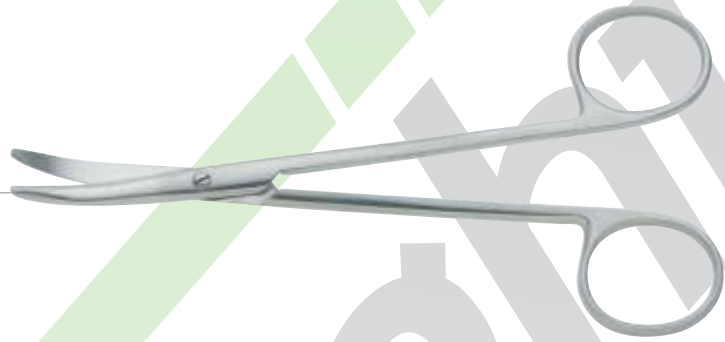

**CT-108-40354** **Fomon**  
14.5 cm, angled, TC

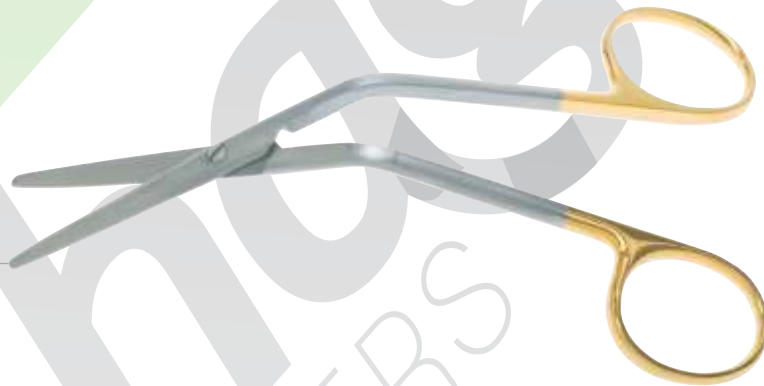

**CT-108-40716** **Cottle**  
17.0 cm, angled, TC



## Scissors

- Caplan Septum**
- CT-146-26120** 22.0 cm, one blade serrated, double action, straight
  - CT-146-26122** 22.0 cm, one blade serrated, double action, curved



- Metzenbaum blunt/blunt**
- CT-108-28415** 14.5 cm, straight, TC
  - CT-108-28515** 14.5 cm, curved, TC
  - CT-108-28418** 18.0 cm, straight, TC
  - CT-108-28518** 18.0 cm, curved, TC
  - CT-108-28420** 20.5 cm, straight, TC
  - CT-108-28520** 20.5 cm, curved, TC
  - CT-108-28423** 23.0 cm, straight, TC
  - CT-108-28523** 23.0 cm, curved, TC
  - CT-108-28428** 28.0 cm, straight, TC
  - CT-108-28528** 28.0 cm, curved, TC
- for serrated blades please add "WS"



- Metzenbaum, blunt/blunt**
- CT-107-28015** 14.5 cm, straight, supercut
  - CT-107-28115** 14.5 cm, curved, supercut
  - CT-107-28018** 18.0 cm, straight, supercut
  - CT-107-28118** 18.0 cm, curved, supercut
  - CT-107-28023** 23.0 cm, straight, supercut
  - CT-107-28123** 23.0 cm, curved, supercut



## Scissors

### Metzenbaum Fino blunt/blunt

<b>CT-108-28615</b>	14.5 cm, straight, TC
<b>CT-108-28715</b>	14.5 cm, curved, TC
<b>CT-108-28618</b>	18.0 cm, straight, TC
<b>CT-108-28718</b>	18.0 cm, curved, TC
<b>CT-108-28620</b>	20.0 cm, straight, TC
<b>CT-108-28720</b>	20.0 cm, curved, TC
<b>CT-108-28623</b>	23.0 cm, straight, TC
<b>CT-108-28723</b>	23.0 cm, curved, TC
<b>CT-108-28628</b>	28.0 cm, straight, TC
<b>CT-108-28728</b>	28.0 cm, curved, TC

for serrated blades please add "WS"

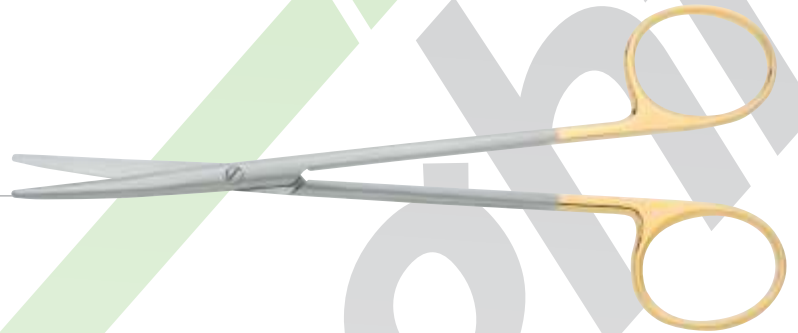

### Metzenbaum sharp/sharp

<b>CT-108-27415</b>	14.5 cm, straight, TC
<b>CT-108-27515</b>	14.5 cm, curved, TC
<b>CT-108-27418</b>	18.0 cm, straight, TC
<b>CT-108-27518</b>	18.0 cm, curved, TC
<b>CT-108-27423</b>	23.0 cm, straight, TC
<b>CT-108-27523</b>	23.0 cm, curved, TC

for serrated blades please add "WS"

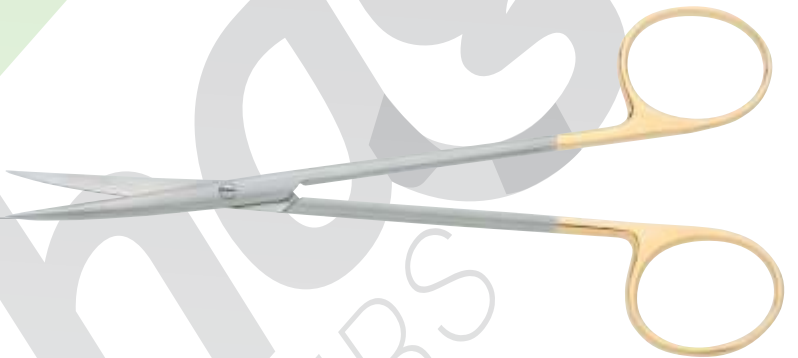

### Mayo-Stille

<b>CT-108-17415</b>	15.0 cm, straight, TC
<b>CT-108-17515</b>	15.0 cm, curved, TC
<b>CT-108-17417</b>	17.0 cm, straight, TC
<b>CT-108-17517</b>	17.0 cm, curved, TC

for serrated blades please add "WS"

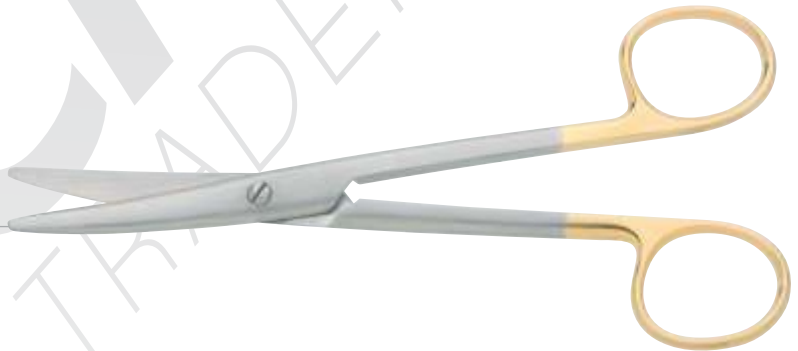

## Scissors

- Mayo-Stille**  
**CT-107-17017** 17.0 cm, straight, supercut  
**CT-107-17117** 17.0 cm, curved, supercut

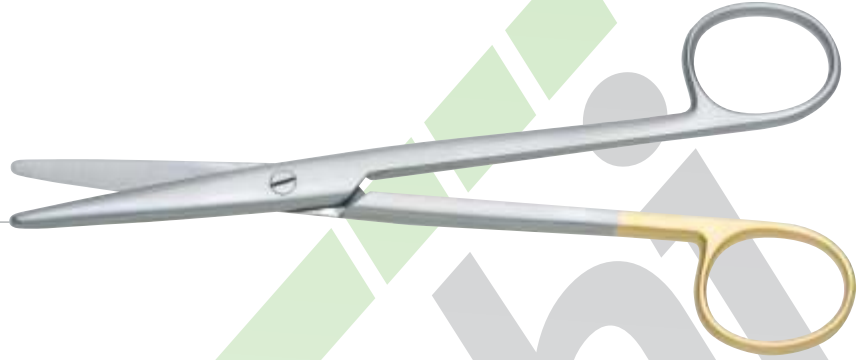

- Mayo-Lexer**  
**CT-108-19421** 21.0 cm, straight, TC  
**CT-108-19521** 21.0 cm, curved, TC



- Operating sharp/blunt**  
**CT-108-11214** 14.5 cm, straight, round, TC  
**CT-108-11314** 14.5 cm, curved, round, TC

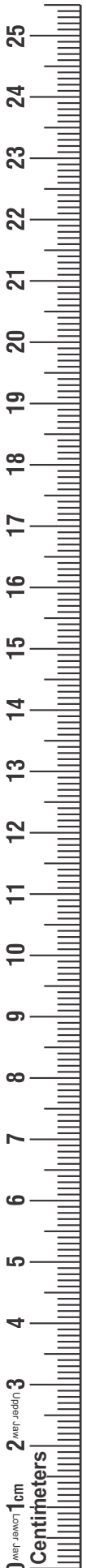

## Scissors

- Operating sharp/sharp**  
**CT-108-12214** 14.5 cm, straight, round, TC  
**CT-108-12314** 14.5 cm, curved, round, TC

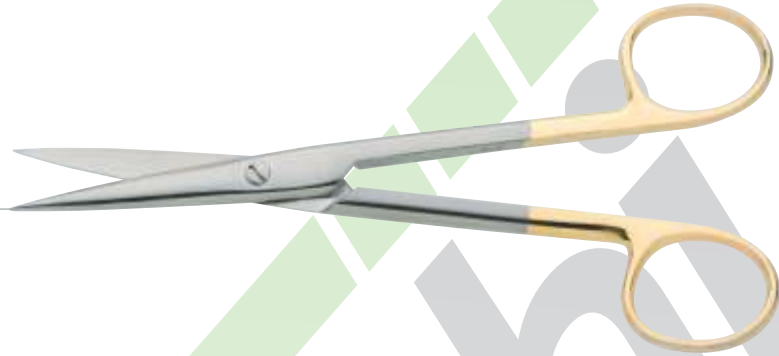

- Operating blunt/blunt**  
**CT-108-10614** 14.5 cm, straight, round, TC  
**CT-108-10714** 14.5 cm, curved, round, TC



- Universal Wire Scissors**  
**CT-108-83512** 12.0 cm, serrated, TC



- Stevens Tenotomy Scissors**  
**CT-108-36509** 9.5 cm, curved, sharp/sharp, ribbon type  
**CT-108-36512** 12.0 cm, curved, sharp/sharp, ribbon type



## Scissors

### Iris

- CT-108-32209** 9.5 cm, straight, sharp/sharp, ribbon type
- CT-108-32309** 9.5 cm, curved, sharp/sharp, ribbon type
- CT-108-32610** 10.5 cm, straight, sharp/sharp, ribbon type
- CT-108-32710** 10.5 cm, curved, sharp/sharp, ribbon type

### Littler

- CT-108-20512** 12.0 cm, curved, tips with eye for suture
- CT-108-20514** 14.0 cm, curved, tips with eye for suture

### Spencer

- CT-108-80209** 9.0 cm, straight, ligature scissor

### Knowles Bandage

- CT-108-93114** 14.0 cm, angled, serrated



## Scissors

### Lister Bandage

- CT-108-90114** 14.0 cm, angled  
**CT-108-90118** 18.0 cm, angled



### Freeman Kaye

- CT-108-21617** 17.0 cm, curved

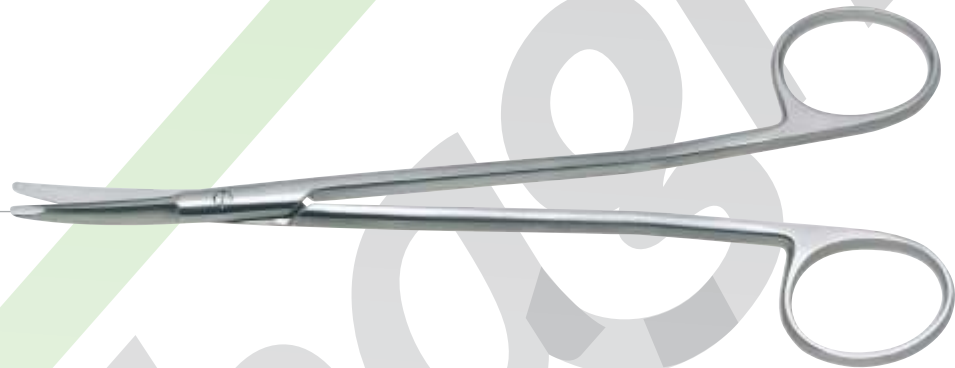

### Micro Scissors

spring scissors with round handle, blade 14 mm

- CT-109-20615** 15.0 cm, straight  
**CT-109-20815** 15.0 cm, straight, blades serrated  
**CT-109-20715** 15.0 cm, curved  
**CT-109-20915** 15.0 cm, curved, blades serrated  
**CT-109-20618** 18.0 cm, straight  
**CT-109-20818** 18.0 cm, straight, blades serrated  
**CT-109-20718** 18.0 cm, curved  
**CT-109-20918** 18.0 cm, curved, blades serrated



## Needle Holders

- Webster**
- CT-124-12811 11.5 cm, smooth
  - CT-124-12913 13.0 cm, smooth, TC



- Halsey**
- CT-124-13413 13.0 cm, smooth, TC
  - CT-124-14413 13.0 cm, cross serrated, TC



- Par**
- CT-124-14011 11.5 cm, cross serrated, TC
  - CT-124-14013 13.0 cm, cross serrated, TC





## Needle Holders

- Derf**  
**CT-124-11012** 12.0 cm, serrated  
**CT-124-11412** 12.0 cm, cross serrated, TC



- Neivert**  
**CT-124-14713** 13.0 cm, cross serrated, TC



- Swedish**  
**CT-124-21815** 15.5 cm, cross serrated, TC



## Needle Holders

### Ryder

- CT-124-22413 13.0 cm, cross serrated, TC
- CT-124-22415 15.0 cm, cross serrated, TC
- CT-124-22418 18.0 cm, cross serrated, TC

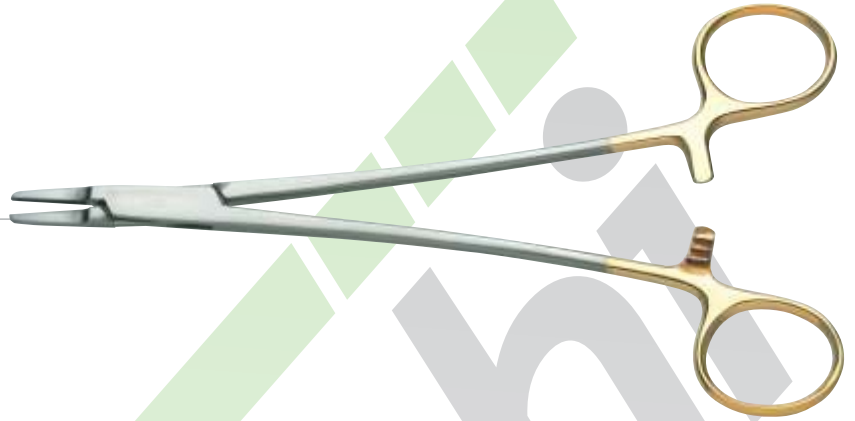

### Micro Ryder

- CT-124-22613 13.0 cm, cross serrated, TC
- CT-124-22615 15.0 cm, cross serrated, TC
- CT-124-22618 18.0 cm, cross serrated, TC

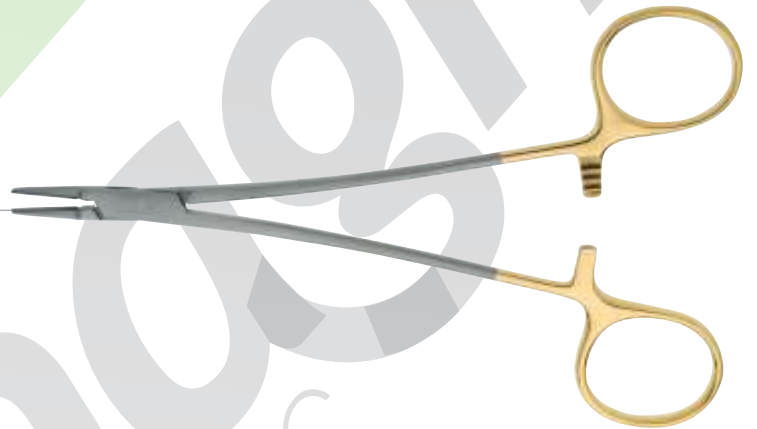

### Euphrate-Pasque

extremely delicate

- CT-124-23814 14.0 cm, cross serrated, TC
- CT-124-23815 15.0 cm, cross serrated, TC
- CT-124-23818 18.0 cm, cross serrated, TC
- CT-124-23820 20.0 cm, cross serrated, TC

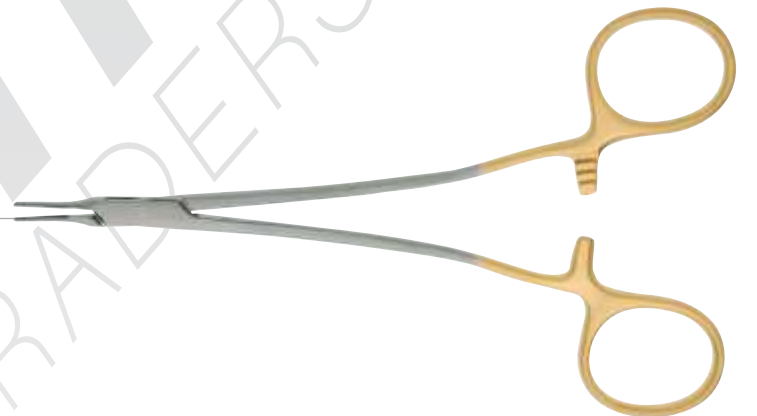

## Needle Holders

### Micro-Vascular

- CT-124-23415** 15.0 cm, cross serrated, TC
- CT-124-23418** 18.0 cm, cross serrated, TC



### Crile-Wood

- CT-124-16215** 15.0 cm, smooth, TC
- CT-124-16415** 15.0 cm, cross serrated, TC
- CT-124-16418** 18.0 cm, cross serrated, TC
- CT-124-16420** 20.0 cm, cross serrated, TC
- CT-124-16423** 23.0 cm, cross serrated, TC



### Lemmon

- CT-124-24814** 14.0 cm, cross serrated, TC
- CT-124-24817** 17.0 cm, cross serrated, TC
- CT-124-24819** 19.0 cm, cross serrated, TC



## Needle Holders

### Baumgartner

- CT-124-15412** 12.5 cm, cross serrated, TC
- CT-124-15414** 14.0 cm, cross serrated, TC



### Mayo Hegar

- CT-124-18414** 14.0 cm, cross serrated, TC
- CT-124-18416** 16.0 cm, cross serrated, TC
- CT-124-18418** 18.0 cm, cross serrated, TC
- CT-124-18420** 20.0 cm, cross serrated, TC

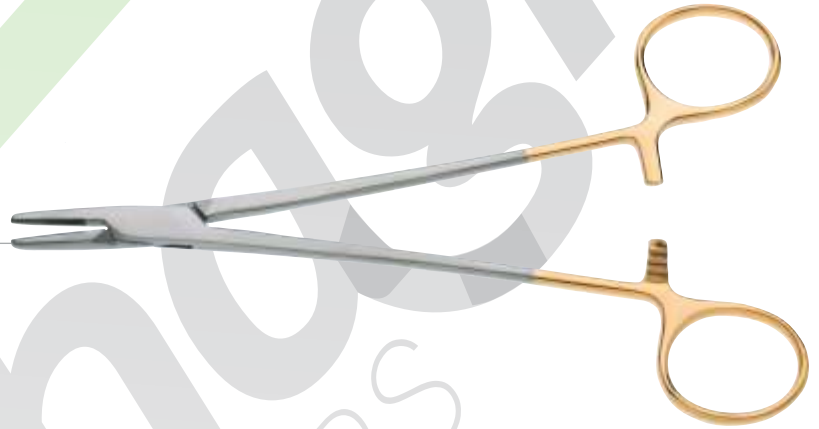

### Wire Twister

- CT-133-60011** 13.0 cm, round jaw, cross serrated, TC
- CT-133-60001** 16.0 cm, blunt jaw, cross serrated, TC
- CT-133-60012** 18.0 cm, round jaw, cross serrated, TC
- CT-133-60002** 18.0 cm, blunt jaw, cross serrated, TC



## Needle Holders

### Corwin Wire Twister

- CT-133-53901 16.0 cm, long round jaw, cross serrated, TC
- CT-133-53902 16.0 cm, blunt jaw, cross serrated, TC
- CT-133-53903 16.0 cm, round jaw, cross serrated, TC



### Olsen Hegar

needleholder/scissors combination

- CT-124-41414 14.0 cm, cross serrated, TC
- CT-124-41418 18.0 cm, cross serrated, TC



### Gillies

needleholder/scissors combination

- CT-124-43416 16.0 cm, cross serrated, curved, TC



## Needle Holders

### Barraquer Micro

with round handle, without lock, tip 0.8 × 1.2 mm

- CT-124-64014** 14.0 cm,  
straight, diamond dusted
- CT-124-64114** 14.0 cm,  
curved, diamond dusted
- CT-124-64015** 15.0 cm,  
straight, diamond dusted
- CT-124-64115** 15.0 cm,  
curved, diamond dusted
- CT-124-64018** 18.0 cm,  
straight, diamond dusted
- CT-124-64118** 18.0 cm,  
curved, diamond dusted

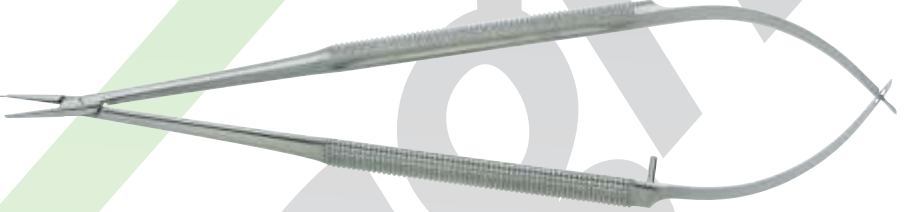

### Barraquer Micro

with round handle, with lock, tip 0.8 × 1.2 mm

- CT-124-64214** 14.0 cm,  
straight, diamond dusted
- CT-124-64314** 14.0 cm,  
curved, diamond dusted
- CT-124-64215** 15.0 cm,  
straight, diamond dusted
- CT-124-64315** 15.0 cm,  
curved, diamond dusted
- CT-124-64218** 18.0 cm,  
straight, diamond dusted
- CT-124-64318** 18.0 cm,  
curved, diamond dusted

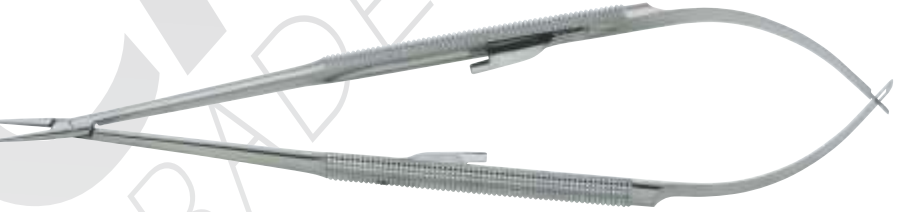

## Needle Holders

### Barraquer Delicate

with round handle, without lock, tip 1.2 × 1.8 mm

- CT-124-63414** 14.0 cm,  
cross serrated, straight, TC
- CT-124-63514** 14.0 cm,  
cross serrated, curved, TC
- CT-124-63415** 15.0 cm,  
cross serrated, straight, TC
- CT-124-63515** 15.0 cm,  
cross serrated, curved, TC
- CT-124-63418** 18.0 cm,  
cross serrated, straight, TC
- CT-124-63518** 18.0 cm,  
cross serrated, curved, TC



### Barraquer Micro

with round handle, without lock, tip 0.8 × 1.2 mm

- CT-124-63614** 14.0 cm,  
cross serrated, straight, TC
- CT-124-63714** 14.0 cm,  
cross serrated, curved, TC
- CT-124-63615** 15.0 cm,  
cross serrated, straight, TC
- CT-124-63715** 15.0 cm,  
cross serrated, curved, TC
- CT-124-63618** 18.0 cm,  
cross serrated, straight, TC
- CT-124-63718** 18.0 cm,  
cross serrated, curved, TC



## Needle Holders

- Barraquer Delicate**  
with round handle, with lock, tip 1.2 × 1.8 mm
- CT-124-66714** 14.0 cm, cross serrated, straight, TC
  - CT-124-66614** 14.0 cm, cross serrated, curved, TC
  - CT-124-66715** 15.0 cm, cross serrated, straight, TC
  - CT-124-66615** 15.0 cm, cross serrated, curved, TC
  - CT-124-66718** 18.0 cm, cross serrated, straight, TC
  - CT-124-66618** 18.0 cm, cross serrated, curved, TC



- Barraquer Micro**  
with round handle, with lock, tip 0.8 × 1.2 mm
- CT-124-66814** 14.0 cm, cross serrated, straight, TC
  - CT-124-66914** 14.0 cm, cross serrated, curved, TC
  - CT-124-66815** 15.0 cm, cross serrated, straight, TC
  - CT-124-66915** 15.0 cm, cross serrated, curved, TC
  - CT-124-66818** 18.0 cm, cross serrated, straight, TC
  - CT-124-66918** 18.0 cm, cross serrated, curved, TC

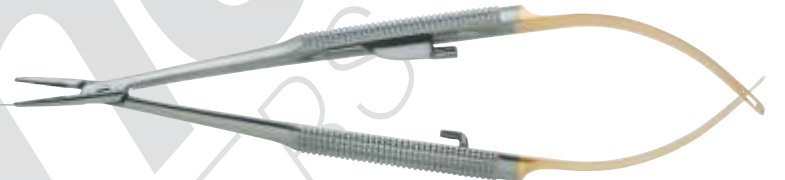

- Castroviejo**  
with fat handle, with lock
- CT-124-67813** 14.0 cm, smooth, straight, TC
  - CT-124-67814** 14.0 cm, cross serrated, straight, TC
  - CT-124-67513** 14.0 cm, smooth, curved, TC
  - CT-124-67514** 14.0 cm, cross serrated, curved, TC
  - CT-124-67817** 18.0 cm, smooth, straight, TC
  - CT-124-67819** 18.0 cm, cross serrated, straight, TC
  - CT-124-67517** 18.0 cm, smooth, curved, TC
  - CT-124-67518** 18.0 cm, cross serrated, curved, TC





## Needle Holders

### Castroviejo

with fat handle, without lock

- CT-124-69614** 14.0 cm, straight, diamond dusted
- CT-124-69714** 14.0 cm, curved, diamond dusted
- CT-124-69618** 18.0 cm, straight, diamond dusted
- CT-124-69718** 18.0 cm, curved, diamond dusted

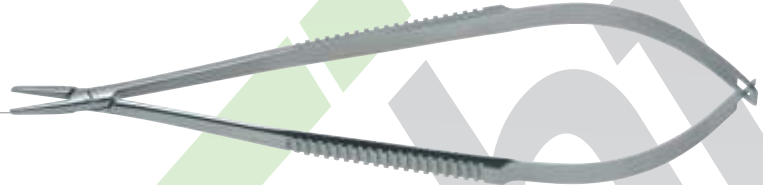

### Castroviejo

with fat handle, with lock

- CT-124-69814** 14.0 cm, straight, diamond dusted
- CT-124-69914** 14.0 cm, curved, diamond dusted
- CT-124-69818** 18.0 cm, straight, diamond dusted
- CT-124-69918** 18.0 cm, curved, diamond dusted



### Castroviejo Ryder

with fat handle, with lock

- CT-124-70214** 14.0 cm, cross serrated, straight, TC
- CT-124-70218** 18.0 cm, cross serrated, straight, TC

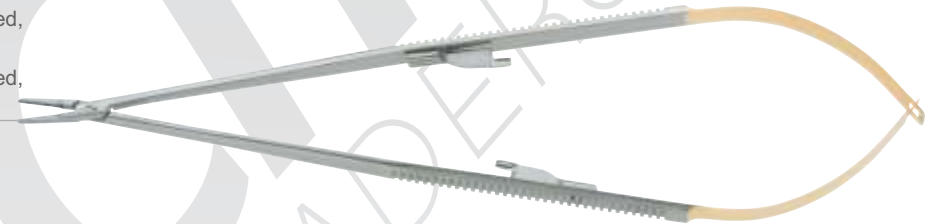







### Barraquer

with round handle, with inserted jaws 0.75mm

- CT-124-65712** 12.0 cm, straight, without lock, smooth
- CT-124-65912** 12.0 cm, curved, without lock, smooth



## Forceps / Thumb

- |   |                              |  |
|---|------------------------------|--|
| <p><b>CT-110-17412</b> 12.0 cm, cross serrated, TC</p> <p><b>CT-110-17415</b> 15.0 cm, cross serrated, TC</p>                       | <p><b>Adson</b></p>          |    |
| <p><b>CT-110-20412</b> 12.0 cm, serrated, Titanium</p>  | <p><b>Adson</b></p>          |    |
| <p><b>CT-110-17012</b> 12.0 cm, serrated</p> <p><b>CT-110-17612</b> 12.0 cm, serrated, Micro</p>                                    | <p><b>Adson</b></p>          |   |
| <p><b>CT-110-17912</b> 12.0 cm, cross serrated</p>  | <p><b>Adson Dressing</b></p> |  |
| <p><b>CT-110-17512</b> 12.0 cm, cross serrated, 1x2 teeth, TC</p> <p><b>CT-110-17515</b> 15.0 cm, cross serrated, 1x2 teeth, TC</p> | <p><b>Adson</b></p>          |  |
| <p><b>CT-110-20512</b> 12.0 cm, smooth, 1x2 teeth, Titanium</p>   | <p><b>Adson</b></p>          |  |
| <p><b>CT-110-18012</b> 12.0 cm, smooth, 1x2 teeth</p>   | <p><b>Adson Tissue</b></p>   |  |



## Forceps / Thumb

<b>CT-110-18512</b>	<b>Adson Tubiana</b> 12.0 cm, 1x2 teeth, with platform 1 mm	
<b>CT-110-18802</b>	<b>Brown-Adson</b> 12.0 cm, cross serrated, Brown teeth, TC	
<b>CT-110-18805</b>	15.0 cm, cross serrated, Brown teeth, TC	
<b>CT-110-18812</b>	<b>Brown-Adson</b> 12.0 cm, Brown teeth	
<b>CT-110-17312</b>	<b>Adson Micro</b> 12.0 cm, cross serrated, 1x2 teeth, TC	
<b>CT-110-17315</b>	15.0 cm, cross serrated, 1x2 teeth, TC	
<b>CT-110-17452</b>	<b>Par</b> 12.0 cm, cross serrated, TC	
<b>CT-110-16912</b>	<b>Adson Delicate</b> 12.0 cm, smooth, TC	
<b>CT-110-17455</b>	15.0 cm, cross serrated, TC	
<b>CT-110-18612D</b>	<b>Gorney-Adson</b> 12.0 cm, 1x2 teeth, with platform, diamond dusted	



## Forceps / Thumb

### Castroviejo

- CT-143-14915** 10,5 cm, 1.5 mm tip, 1x2 teeth, with platform
- CT-143-14903** 10,5 cm, 3 mm tip, 1x2 teeth, with platform
- CT-143-14905** 10,5 cm, 5 mm tip, 1x2 teeth, with platform
- CT-143-14909** 10,5 cm, 9 mm tip, 1x2 teeth, with platform



### Castroviejo-Brown

- CT-110-18851** 11.0 cm, brown teeth



### Graefe Iris

- CT-142-82010** 10.0 cm, smooth, 1x2 teeth



### Graefe Iris

- CT-142-81010** 10.0 cm, serrated



### Julian Suture

- CT-142-82511** 11.0 cm, smooth, curved



### Adson-Graefe

- CT-110-20012** 12.0 cm, multi-toothed

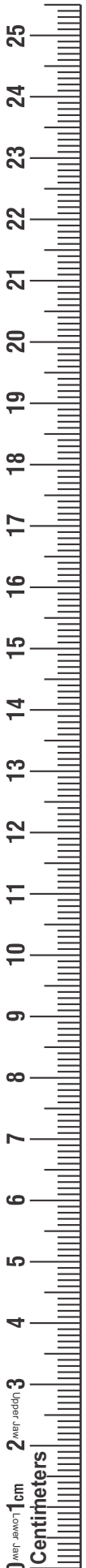

## Forceps / Thumb

### Bishop-Harmon

- CT-142-94004** 8.5 cm, smooth, 1x2 teeth, fine  
**CT-142-94006** 8.5 cm, smooth, 1x2 teeth



### Green Fixation

- CT-143-07605** 10.0 cm, 5 mm tip, without lock  
**CT-143-07610** 10.0 cm, 10 mm tip, without lock  
**CT-143-07612** 10.0 cm, 12 mm tip, without lock  
**CT-143-07805** 10.0 cm, 5 mm tip, with lock  
**CT-143-07810** 10.0 cm, 10 mm tip, with lock  
**CT-143-07812** 10.0 cm, 12 mm tip, with lock



### Semken

- CT-110-26915** 15.0 cm, cross-serrated, 1x2 teeth, TC



### McIndoe Dissecting

- CT-110-25815** 15.0 cm, serrated



### Gillies Dissecting

- CT-110-27215** 15.0 cm, cross serrated, 1x2 teeth



### General

- CT-110-11115** 15.0 cm, cross serrated, TC



## Forceps / Thumb

- 
- Cushing**  
CT-110-22417 17.0 cm, cross serrated, TC
- Cushing**  
CT-110-22217 17.0 cm, serrated, Titanium
- Cushing**  
CT-110-22517 17.0 cm, angled, cross serrated, TC
- Taylor Cushing**  
CT-110-22618 18.5 cm, cross serrated, bayonet, TC
- Bonney**  
CT-110-25317 17.5 cm, cross serrated, 1x2 teeth, TC
- Potts-Smith**  
CT-110-11618 18.0 cm, cross serrated, TC  
CT-110-11621 21.0 cm, cross serrated, TC  
CT-110-11625 25.0 cm, cross serrated, TC

## Forceps / Thumb

### Gerald

- CT-110-30618** 18.0 cm, cross serrated, 1x2 teeth, TC
- CT-110-30118** 18.0 cm, cross serrated, TC



### Skinner

- CT-110-32323** 23.0 cm, cross serrated, 1x2 teeth, TC



### DeBakey Titanium

- CT-111-30015** 15.0 cm, 1.5 mm tip, Titanium
- CT-111-30020** 19.5 cm, 1.5 mm tip, Titanium
- CT-111-30024** 24.0 cm, 1.5 mm tip, Titanium
- CT-111-30315** 15.0 cm, 2.3 mm tip, Titanium
- CT-111-30320** 19.5 cm, 2.3 mm tip, Titanium
- CT-111-30324** 24.0 cm, 2.3 mm tip, Titanium



### DeBakey

- CT-111-30616** 16.0 cm, 1.5 mm jaw
- CT-111-30620** 20.0 cm, 1.5 mm jaw
- CT-111-30624** 24.0 cm, 1.5 mm jaw
- CT-111-30816** 16.0 cm, 2.0 mm jaw
- CT-111-30820** 20.0 cm, 2.0 mm jaw
- CT-111-30824** 24.0 cm, 2.0 mm jaw
- CT-111-30830** 30.0 cm, 2.0 mm jaw
- CT-111-30416** 16.0 cm, 2.7 mm jaw
- CT-111-30420** 20.0 cm, 2.7 mm jaw
- CT-111-30424** 24.0 cm, 2.7 mm jaw
- CT-111-30430** 30.0 cm, 2.7 mm jaw
- CT-111-31016** 16.0 cm, 3.5 mm jaw
- CT-111-31020** 20.0 cm, 3.5 mm jaw
- CT-111-31024** 24.0 cm, 3.5 mm jaw
- CT-111-31030** 30.0 cm, 3.5 mm jaw



**Forceps / Thumb**

**CT-144-20616** **Lucae-Jansen**  
16.0 cm, serrated



**CT-146-15420** **Jansen Gruenwald**  
20.0 cm, serrated









**CT-144-20614** **Lucae**  
14.0 cm, serrated













## Forceps / Thumb

### Jewelers diamond dusted

<b>CT-110-33525</b>		11.5 cm, # 5A, very fine pointed tips
<b>CT-110-33503</b>		11.5 cm, # 3, straight, delicate tips
<b>CT-110-33504</b>		11.5 cm, # 4, straight, very fine tips
<b>CT-110-33505</b>		11.0 cm, # 5, straight, ultra fine tips
<b>CT-110-33515</b>		11.0 cm, # 5/45, angled, ultra fine tips
<b>CT-110-33507</b>		11.5 cm, # 7, curved, delicate tips



### Jewelers

<b>D110-33201</b>		11.5 cm, # 1, straight, standard tips
<b>CT-110-33012</b>		11.5 cm, # 3, straight, delicate tips
<b>CT-110-33225</b>		11.0 cm, # 5A, very fine pointed tips
<b>CT-110-33010</b>		10.5 cm, # 3C, straight, delicate tips
<b>CT-110-33204</b>		11.0 cm, # 4, straight, very fine tips
<b>CT-110-33205</b>		11.0 cm, # 5, straight, ultra fine tips
<b>CT-110-33100</b>		11.0 cm, # 5/45, angled, ultra fine tips
<b>CT-110-33112</b>		11.0 cm, # 7, curved, delicate tips



### Micro-Forceps

round handle, with tying platform

<b>CT-111-10415</b>	15.0 cm, straight, smooth
<b>CT-111-10818</b>	18.0 cm, straight, smooth
<b>CT-111-10515</b>	15.0 cm, curved, smooth
<b>CT-111-10918</b>	18.0 cm, curved, smooth



## Nasal Rasps

- Fomon**  
**CT-146-52201** 20.0 cm, #1 and #2, TC  
**CT-146-52203** 20.0 cm, #3 and #4, TC  
**CT-146-52205** 20.0 cm, #5 and #6, TC  
**CT-146-52207** 20.0 cm, #7 and #8, TC



- Glabella**  
**CT-146-50501** 21.5 cm, TC



- Peet**  
**CT-146-50919** 19.0 cm, straight  
**CT-146-50920** 19.0 cm, curved



- Miller Colburn File**  
**CT-182-89501** 18.0 cm, #1  
**CT-182-89502** 18.0 cm, #2  
**CT-182-89503** 18.0 cm, #3  
**CT-182-89504** 18.0 cm, #4  
**CT-182-89505** 18.0 cm, #5



- McIndoe**  
**CT-146-53018** 17.5 cm, forward cutting, straight



## Nasal Raspers

- CT-146-51916** **Maltz**  
16.5 cm, backward cutting, straight
- CT-146-53101** **Lamont**  
17.5 cm, backward cutting, wide, straight, aggressive teeth
- CT-146-53102** **Lamont**  
17.5 cm, backward cutting, delicate, straight, fine teeth
- CT-146-53103** **Lamont**  
17.5 cm, backward cutting, straight, fine teeth
- CT-146-50604** **Parkes**  
21.0 cm, # 4, backward cutting, straight, TC
- CT-146-50605**  
21.0 cm, # 5, backward cutting, straight, TC
- CT-146-50608**  
21.0 cm, # 8, backward cutting, straight, TC
- 



## Nasal Rasps

**Peet Aufricht**  
21.0 cm,  
fne curved,  
diamond dusted

CT-146-51022



**Fomon**  
21.5 cm, fne

CT-146-52401



**Fomon**  
21.5 cm, coarse

CT-146-52402



**Fomon**  
21.0 cm,  
diamond dusted

CT-146-52321



## Nasal Rasps



## Retractors

**Ferreira retractor**  
**CT-148-56411** 11.0 cm x 2.2 cm, face lift retractor with fberoptic



**Flap retractor**  
**CT-118-56112** 11.0 cm, 2.2 cm blade



**Tebbetts Style**  
 T-Mammoplasty retractor with smoke evacuation tube and fberoptical illumination, with Storz, HSW, ACMI adapter included

- CT-118-55080** 16 x 80 mm blade, without teeth
- CT-118-55090** 24 x 90 mm blade, without teeth
- CT-118-55092** 30 x 90 mm blade, without teeth
- CT-118-55100** 24 x 100 mm blade, without teeth
- CT-118-55120** 25 x 120 mm blade, without teeth
- CT-118-55122** 30 x 120 mm blade, without teeth
- CT-118-55150** 25 x 150 mm blade, without teeth
- CT-118-55152** 30 x 150 mm blade, without teeth
- CT-118-55154** 36 x 150 mm blade, without teeth
- CT-118-55170** 40 x 170 mm blade, without teeth
- CT-118-55190** 30 x 190 mm blade, without teeth
- CT-118-55480** 16 x 80 mm blade, with teeth
- CT-118-55490** 24 x 90 mm blade, with teeth
- CT-118-55492** 30 x 90 mm blade, with teeth
- CT-118-55500** 24 x 100 mm blade, with teeth
- CT-118-55520** 25 x 120 mm blade, with teeth
- CT-118-55522** 30 x 120 mm blade, with teeth
- CT-118-55550** 25 x 150 mm blade, with teeth
- CT-118-55552** 30 x 150 mm blade, with teeth
- CT-118-55554** 36 x 150 mm blade, with teeth
- CT-118-55570** 40 x 170 mm blade, with teeth
- CT-118-55590** 30 x 190 mm blade, with teeth

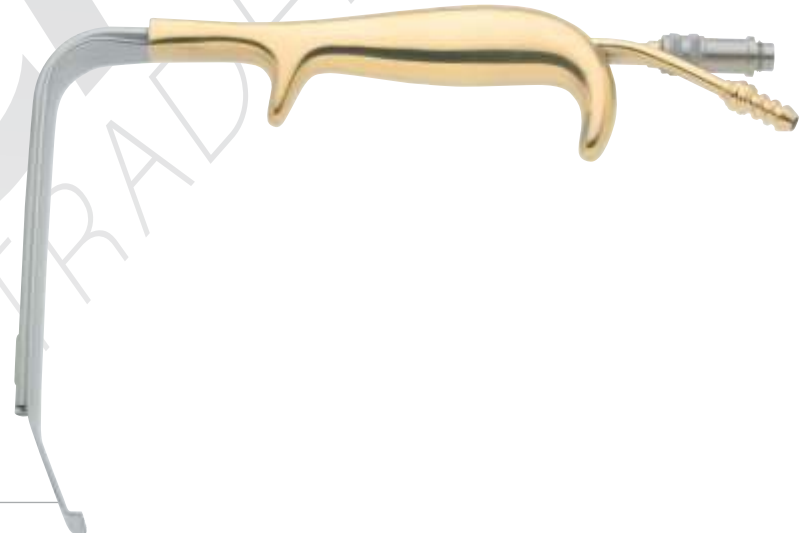

## Retractors

**CT-118-17925** **Deaver**  
20.0 cm, retractor with fiberoptic



**CT-118-19612** **Freeman Flap**  
20.5 cm, retractor, 12 mm blade width

**CT-118-19625**  
20.5 cm, retractor, 25 mm blade width



**CT-118-56019** **Multiple approach retractor**  
19.0 cm, 23 mm blade



## Retractors

- CT-118-57001** standard blade, 50 mm  
**CT-118-57011** standard blade with fiber-optics, 50 mm  
**CT-118-57021** standard blade with fiber-optics and suction tube, 50 mm  
**CT-118-57002** narrow blade, 31 mm  
**CT-118-57012** narrow blade with fiber-optics, 31 mm  
**CT-118-57022** narrow blade with fiber-optics and suction tube, 31 mm

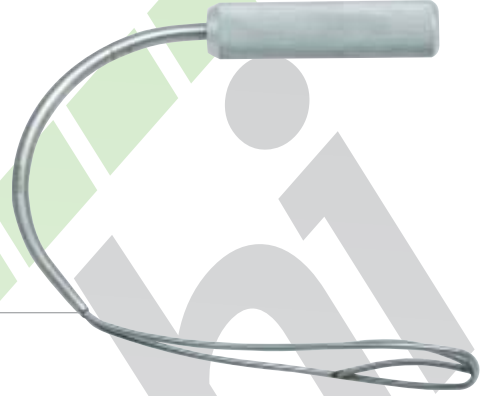

### Converse

- CT-146-54105** 11.0 cm, nasal retractor,  
11x44 mm blade  
**CT-146-54125** 11.0 cm, nasal retractor,  
11x44 mm blade, with fiber optics



### Aufricht

- CT-146-55116** 16.0 cm, nasal retractor,  
45 mm blade  
**CT-146-55126** 16.0 cm, nasal retractor,  
45 mm blade, with fiber optics



### Cottle

- CT-146-55920** 20.0 cm, retractor  
with knife guard





## Retractors

- CT-118-65010** **Weitlaner**  
11.5 cm, retractor,  
2x3 sharp prongs
- CT-118-67014**  
14.0 cm, retractor,  
3x4 sharp prongs



- CT-146-55508** **Swivel double hook**  
8.0 cm, sharp, 10 mm

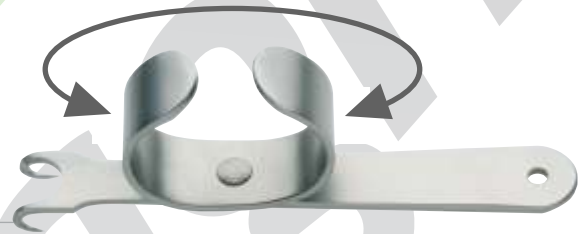

- CT-146-54516** **Sheen**  
16.0 cm, nasal retractor



- CT-118-17731** **Spatula,**  
semi-malleable  
31.5 cm, 2.5x15.5 cm blade



## Retractors

**CT-118-19516** **Hamra**  
16.0 cm, double ended retractor



**CT-146-55614** **Cottle**  
14.0 cm, retractor, double hook, sharp



**CT-146-55616** **Fomon**  
16.0 cm, alar retractor, double hook with ball ends



**CT-146-55412** **Converse Alar**  
10.0 cm, retractor double ended, 10mm / 14mm, blunt



**CT-146-55511** **Martinez Kilner**  
11.5 cm, retractor double hook with thimble, 10mm wide, sharp



## Retractors

**U.S. Army**  
21.0 cm, retractor,  
double ended, pair

**CT-118-13121**



**Maxwell Flap**  
10.0 cm x 22 mm, four prongs retractor  
10.0 cm x 38 mm, four prongs retractor

**CT-118-25122**

**CT-118-25138**



**Freeman Rake**  
18.0 cm x 22 mm,  
four prongs retractor

**CT-118-25222**

18.0 cm x 38 mm,  
four prongs retractor

**CT-118-25238**



**Anderson Bear Claw**  
11.0 cm, 3 prongs, sharp  
11.0 cm, 5 prongs, sharp

**CT-118-24911**

**CT-118-25011**



## Retractors

**Freeman**  
CT-146-56502 10.0 cm, double skin hook, sharp



**Yancoskie lift retractor**  
CT-118-25615 15.0 cm, 6 prongs



**Lift retractor**  
CT-118-25318 18.0 cm, 7 prongs



## Retractors

**Gorney Rake**  
7.5 cm, retractor with spring, 38mm wide  
**CT-118-25438**



**Rollet**  
13.0 cm, retractor, delicate,  
4 sharp prongs  
**CT-142-37613**



**Miller Rake**  
13.5 cm, tissue retractor, delicate,  
9 sharp prongs  
**CT-118-26513**



**Ragnell**  
15.0 cm, double ended retractor,  
delicate  
**CT-118-24214**



**Ragnell-Davis**  
14.5 cm,  
double ended retractor  
**CT-118-24314**



## Retractors

- Senn**  
**CT-118-16017** 17.0 cm,  
double ended retractor, sharp  
**CT-118-16117** 17.0 cm,  
double ended retractor,  
blunt



- Holtzheimer**  
self retaining retractor, 4 teeth  
**CT-118-63510** 10.0 cm, blunt, straight  
**CT-118-63410** 10.0 cm, sharp, straight  
**CT-118-63710** 10.0 cm, blunt, curved  
**CT-118-63610** 10.0 cm, sharp, curved



- Farr Spring Retractor**  
**CT-118-80120** 14.0 cm x 2.0 cm  
**CT-118-80121** 14.0 cm x 3.0 cm

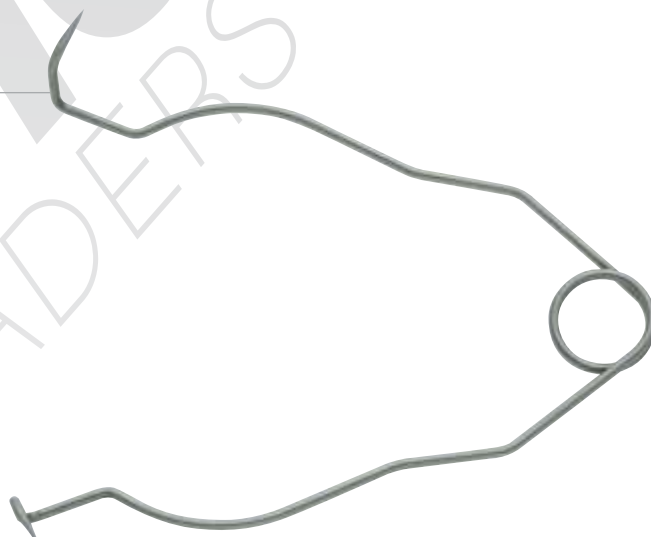

## Retractors

**CT-118-24316** **Kasden**  
16.5 cm,  
double ended retractor



**CT-118-23908** **Kawamoto**  
16.0 cm,  
double ended retractor,  
insulated, 8mm/10mm blades



**CT-118-23914** **Kawamoto**  
16.0 cm,  
double ended retractor,  
insulated, 14mm/16mm blades



**CT-148-58716** **Wise**  
16.5 cm, orbit retractor,  
double ended



**CT-148-90301** **Hajek's**  
18.0 cm, cheek retractor



## Retractors

**CT-146-54615** **Sheen**  
15.0 cm, retractor



**CT-146-56810** **Caroline**  
11.0 cm, finger retractor



**CT-148-57215** **Cronin**  
15.5 cm, lip and nostril retractor



**CT-148-90416** **Cronin**  
16.5 cm, cheek retractor



**CT-148-57701** **Fischl**  
16.0 cm,  
"Shoe Horn" retractor





## Retractors

**Dingman Mouth Gag complete**  
16.6 cm frame, 3 tongue blades

CT-148-32400

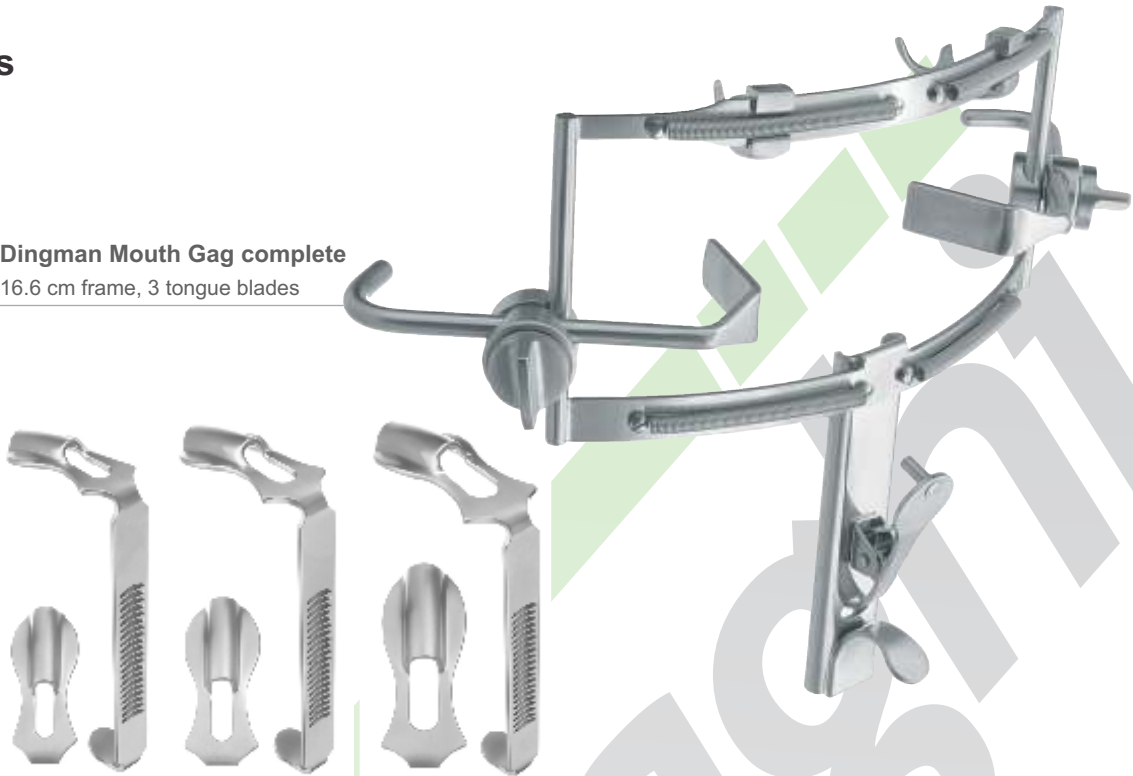

**Lead Hand**

CT-132-45001

adult size

CT-132-45002

child size



## Breast Retractors

**CT-138-30133** 33.0 cm, angled  
**CT-138-30142** 42.0 cm, angled



**CT-138-30233** 33.0 cm, angled, malleable  
**CT-138-30242** 42.0 cm, angled, malleable



**CT-138-30333** 33.0 cm, angled, insulated  
**CT-138-30342** 42.0 cm, angled, insulated



## Breast Retractors

**CT-138-31133** 33.0 cm,  
spatulated

**CT-138-31142** 42.0 cm,  
spatulated

**CT-138-31233** 33.0 cm,  
spatulated, malleable

**CT-138-31242** 42.0 cm, spatulated,  
malleable

**CT-138-31333** 33.0 cm,  
spatulated, insulated

**CT-138-31342** 42.0 cm, spatulated,  
insulated

**CT-138-31432** 32.0 cm,  
oval spatulated  
blade

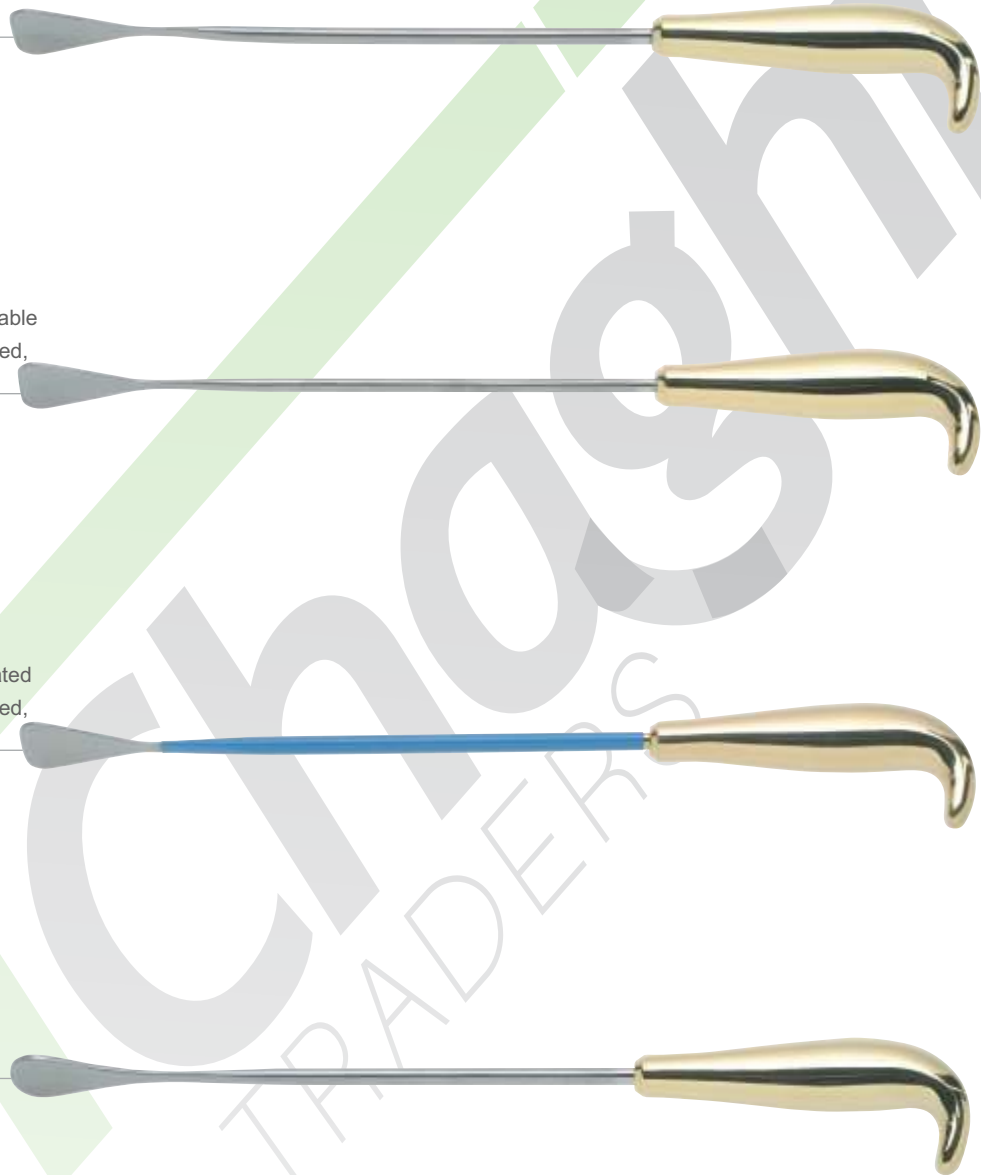

50

## Shaper

- Scalp Dissector**  
**CT-138-32001** 24.0 cm, slightly curved, 12.5 mm wide  
**CT-138-32011** 24.0 cm, slightly curved, 12.5 mm wide, with Ergo Handle

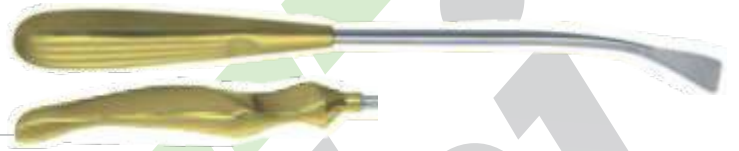

- Scalp Dissector**  
**CT-138-32002** 24.0 cm, half curved, with angled tip, 12.5 mm wide  
**CT-138-32012** 24.0 cm, half curved, with angled tip, 12.5 mm wide, with Ergo Handle



- Dissector**  
**CT-138-32003** 24.0 cm, half curved, 7.0 mm wide  
**CT-138-32013** 24.0 cm, half curved, 7.0 mm wide, with Ergo Handle



- Transoral Dissector**  
**CT-138-32004** 23.5 cm, curved, 7.0 mm wide  
**CT-138-32014** 23.5 cm, curved, 7.0 mm wide, with Ergo Handle



- Dissector**  
**CT-138-32005** 24.0 cm, straight, 7.0 mm wide  
**CT-138-32015** 24.0 cm, straight, 7.0 mm wide, with Ergo Handle



## Shaper

- Flap Dissector**  
**CT-138-32006** 24.0 cm, curved, 6.5 mm wide  
**CT-138-32016** 24.0 cm, curved, 6.5 mm wide,  
 with Ergo Handle

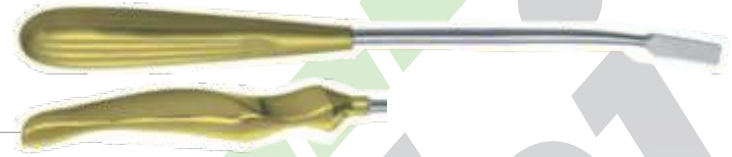

- Frontoglobellar Dissector**  
**CT-138-32007** 26.5 cm, S-shaped  
**CT-138-32017** 26.5 cm, S-shaped,  
 with Ergo Handle

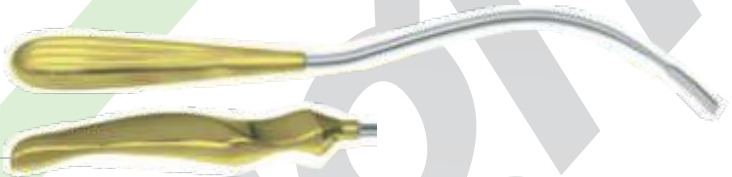

- Midface Fascia Dissector**  
**CT-138-32008** 24.0 cm, S-shaped  
**CT-138-32018** 24.0 cm, S-shaped,  
 with Ergo Handle



- Flap Dissector**  
**CT-138-32009** 22.5 cm, straight, 10 mm wide  
**CT-138-32019** 22.5 cm, straight, 10 mm wide,  
 with Ergo Handle

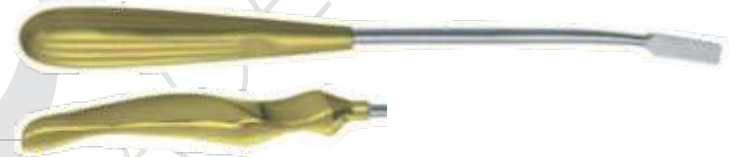

- Periosteal Dissector**  
**CT-138-32101** 24.0 cm, S-shaped, 9 mm wide  
**CT-138-32111** 24.0 cm, S-shaped, 9 mm wide,  
 with Ergo Handle



## Shaper

- Nerve Dissector**  
**CT-138-32102** 24.0 cm, slightly curved  
**CT-138-32112** 24.0 cm, slightly curved,  
 with Ergo Handle



- Orbital Rim Dissector**  
**CT-138-32103** 24.0 cm, half curved  
**CT-138-32113** 24.0 cm, half curved,  
 with Ergo Handle



- Temporal Dissector**  
**CT-138-32104** 23.5 cm, straight  
**CT-138-32114** 23.5 cm, straight,  
 with Ergo Handle



- Periosteal Dissector**  
**CT-138-32105** 25.0 cm, curved  
**CT-138-32115** 25.0 cm, curved,  
 with Ergo Handle

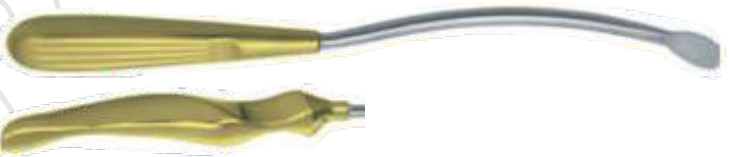

## Shaper

- Nerve Hook**  
**CT-138-33001** 24.0 cm, curved right  
**CT-138-33002** 24.0 cm, curved left

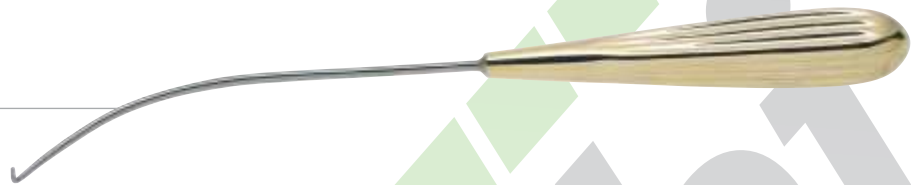

- Nerve Hook**  
**CT-138-33123** 23.5 cm, slightly malleable,  
with graduation



- Nerve Protector**  
**CT-138-33501** 17.0 cm, curved right  
**CT-138-33502** 17.0 cm, curved left



- Suction Elevator**  
**CT-138-34001** slightly curved, round edge



- Scalpel Handle**  
**CT-138-35023** 23.0 cm,  
for small blades, downwards angled



## Osteotomes

- Anderson-Neivert**  
 CT-146-46907 20.0 cm, straight  
 CT-146-46917 20.0 cm, right  
 CT-146-46927 20.0 cm, left



- Gunter**  
 CT-146-46307 21.5 cm, straight  
 CT-146-46317 21.5 cm, right  
 CT-146-46327 21.5 cm, left



- Silver**  
 rhinoplastic chisel  
 CT-146-47301 18.0 cm, straight  
 CT-146-47302 18.0 cm, right  
 CT-146-47303 18.0 cm, left



- Ristow**  
 CT-146-47701 20.5 cm, right  
 CT-146-47702 20.5 cm, left



- Rees**  
 handle aluminium anodized  
 CT-146-44802 20.5 cm, 2 mm  
 CT-146-44803 20.5 cm, 3 mm





## Osteotomes

### Parkes

**CT-146-47518** 16.0 cm, straight



### Converse

**CT-146-47102** 18.0 cm, 2 mm  
**CT-146-47103** 18.0 cm, 3 mm  
**CT-146-47104** 18.0 cm, 4 mm  
**CT-146-47105** 18.0 cm, 5 mm  
**CT-146-47106** 18.0 cm, 6 mm  
**CT-146-47107** 18.0 cm, 7 mm  
**CT-146-47108** 18.0 cm, 8 mm  
**CT-146-47109** 18.0 cm, 9 mm  
**CT-146-47110** 18.0 cm, 10 mm  
**CT-146-47111** 18.0 cm, 11 mm  
**CT-146-47112** 18.0 cm, 12 mm  
**CT-146-47115** 18.0 cm, 15 mm



### Sheehan

**CT-146-46702** 16.0 cm, 2 mm  
**CT-146-46703** 16.0 cm, 3 mm  
**CT-146-46704** 16.0 cm, 4 mm  
**CT-146-46705** 16.0 cm, 5 mm  
**CT-146-46706** 16.0 cm, 6 mm  
**CT-146-46709** 16.0 cm, 9 mm  
**CT-146-46710** 16.0 cm, 10 mm



## Osteotomes

### Cinelli

- CT-146-47210 18.5 cm, 10 mm
- CT-146-47212 18.5 cm, 12 mm
- CT-146-47214 18.5 cm, 14 mm
- CT-146-47216 18.5 cm, 16 mm



### Rubin Type

- CT-146-46810 17.0 cm, 10 mm
- CT-146-46814 17.0 cm, 14 mm
- CT-146-46816 17.0 cm, 16 mm



### Parkes Gouge

- CT-146-47918 18.0 cm, 6.5 mm



### Sheen angled, Radix Chisel

- CT-146-44710 18.0 cm, 10 mm, 10° angle
- CT-146-44720 18.0 cm, 10 mm, 20° angle



### Freer Chisel

- CT-146-45004 16.5 cm, 4 mm, straight



## Mallets

**CT-132-69632** **Mead** 17.0 cm, 320 g  
**CT-132-69702** pair of interchangeable faces

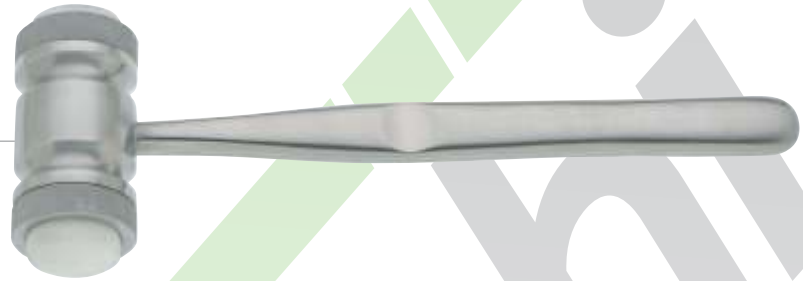

**CT-132-69114** **Nylon** 18.5 cm, head Nylon / Nylon



**CT-132-69214** **Nylon** 18.5 cm, head Nylon / Stainless



**CT-132-68625** **Gerzog** 18.0 cm, 250 g = 8 oz



## Morselizers

**CT-146-25318** **Gunter**  
18.0 cm, serrated, TC

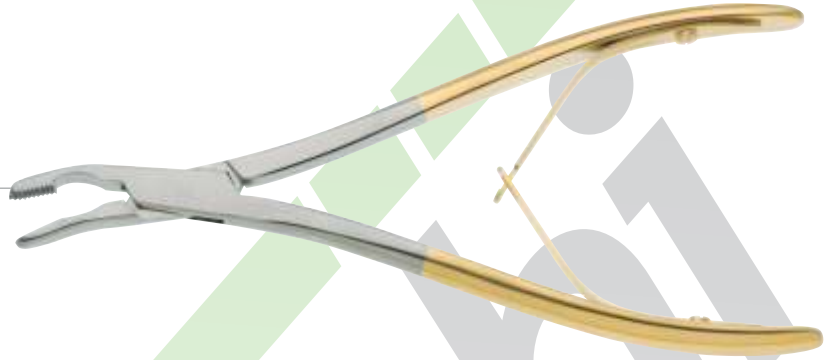

**CT-146-25520** **Gorney**  
18.5 cm, straight



**CT-146-53800** **Cottle**  
cartilage-crusher, including forceps for removal



## Saws

- Joseph Saw**  
**H146-53219** 19.0 cm, left bayonet  
**H146-53419** 19.0 cm, right bayonet



## Curettes

- Converse double ended curette**  
**CT-144-76321** 21.0 cm, 7.0 x 10.0 and 6.5 x 8.5mm



- Fox dermal curette**  
**CT-174-12803** 14.0 cm, 3 mm oval  
**CT-174-12804** 14.0 cm, 4 mm oval  
**CT-174-12805** 14.0 cm, 5 mm oval



## Septum Forceps

- Asch straightening Forceps**  
**CT-146-57123** 23.0 cm



- Walsham straightening Forceps**  
**CT-146-57223** 23.0 cm, straight  
**CT-146-57323** 23.0 cm, left  
**CT-146-57523** 23.0 cm, right



## Nasal Speculas

- Vienna**
- CT-146-11201 14.0 cm, for baby
  - CT-146-11202 14.0 cm, for child
  - CT-146-11203 14.0 cm, for adult



- Killian**
- CT-146-12035 13.0 cm, 35 mm
  - CT-146-12050 13.0 cm, 50 mm
  - CT-146-12075 13.0 cm, 75 mm
  - CT-146-12090 13.0 cm, 90 mm



- Cottle**
- CT-146-12435 14.0 cm, 35 mm
  - CT-146-12450 14.0 cm, 50 mm
  - CT-146-12475 14.0 cm, 75 mm
  - CT-146-12490 14.0 cm, 90 mm



## Elevators

**CT-132-81921** **Rowe's**  
21.0 cm,  
Zygomatic bone elevator



**CT-146-43124** **McCulloch**  
24.0 cm, double ended blunt  
elevator, 4.2 mm



**CT-146-40119** **Gorney Suction**  
19.0 cm, round end,  
suction-elevator



**CT-146-42123** **Cottle Septum**  
23.0 cm



**CT-146-42516** **Joseph**  
16.5 cm, periosteal elevator



## Elevators

- Freer**  
**CT-146-41645** 19.0 cm, tip 4.5 mm, sharp/blunt  
**CT-146-41665** 19.0 cm, tip 6.5 mm, sharp/blunt

- McCollough**  
**CT-146-40418** 18.5 cm

- Woodson**  
**CT-146-50318** 20.0 cm

- Cottle Skin**  
**CT-146-42519** 19.0 cm, 10 mm wide

- Mitchells Trimmer**  
**CT-146-43317** 17.0 cm, knife blade and spoon shaped elevator





## Elevators

**Obwegeser Periosteal**  
**CT-148-69907** 18.0 cm, 7 mm  
**CT-148-69911** 18.0 cm, 11 mm



**Boies**  
**CT-146-57719** 19.5 cm



**Carlin**  
**CT-148-56600** 15.5 cm, chin implant  
 periosteal elevator



**Clodius**  
**CT-148-58500** orbital retractor, double ended,  
 13 mm / 20 mm



## Hooks

**Frazier Skin Hook**  
**CT-118-21413** 13.0 cm, sharp  
**CT-118-21418** 18.0 cm, sharp

**O'Conner Iris Skin Hook**  
**CT-118-20913** 12.5 cm, sharp

**Converse Skin Hook**  
**CT-118-20501** 19.0 cm, small  
**CT-118-20503** 19.0 cm, large

**Joseph Skin Hook**  
**CT-118-21601** 16.0 cm, single hook  
**CT-118-21602** 16.0 cm, 2 mm double hook  
**CT-118-21605** 16.0 cm, 5 mm double hook  
**CT-118-21607** 16.0 cm, 7 mm double hook  
**CT-118-21610** 16.0 cm, 10 mm double hook

**Kleinert-Kutz Hook**  
**CT-118-20803** 16.0 cm, 3 mm  
**CT-118-20805** 16.0 cm, 5 mm  
**CT-118-20807** 16.0 cm, 7 mm



## Hooks

**CT-146-55218** **Millard Thimble Hook**  
18 mm wide, double hook

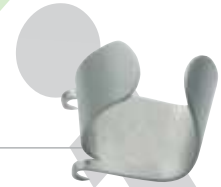

**CT-146-55701** **Cottle Tenaculum**  
15.0 cm, Fig. 1  
**CT-146-55702** 15.0 cm, Fig. 2  
**CT-146-55703** 15.0 cm, Fig. 3



**CT-118-21201** **Guthrie Double Hook**  
12.0 cm, 2.5 mm  
**CT-118-21202** 12.0 cm, 3.0 mm



**CT-118-20413** **Tyrell Skin Hook**  
13.0 cm



**CT-146-56018** **Gillies Skin Hook**  
18.0 cm, Fig. 1  
**CT-146-56218** 18.0 cm, Fig. 2



**CT-146-56614** **Barsky Double Skin Hook**  
15.0 cm, 5 mm



## Measuring



## Dissectors

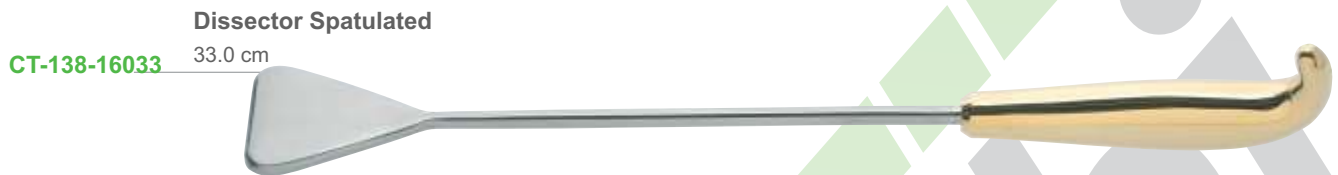

## Markers

**Grossmann**  
Areola Marker  
4 sizes

CT-138-10400



**Freeman**  
Areola Marker

CT-138-10534 34 mm  
CT-138-10536 36 mm  
CT-138-10538 38 mm  
CT-138-10542 42 mm  
CT-138-10545 45 mm  
CT-138-10550 50 mm

CT-138-10534

CT-138-10536

CT-138-10538

CT-138-10542

CT-138-10545

CT-138-10550



**McKissock "keyhole"**  
used in conjunction  
with Freeman Areola Marker

CT-138-11038 38 mm  
CT-138-11042 42 mm  
CT-138-11045 45 mm

CT-138-11038

CT-138-11042

CT-138-11045

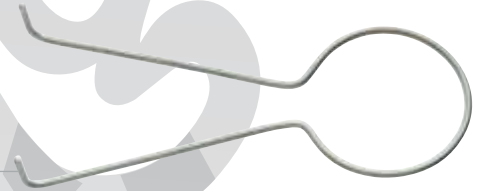

**Freeman**  
38/42 mm diameter  
42/45 mm diameter

CT-138-10738  
CT-138-10742

CT-138-10738

CT-138-10742



**Ackerman**  
Areola Marker

CT-138-11414 10.0 cm  
CT-138-11416 11.5 cm

CT-138-11414

CT-138-11416

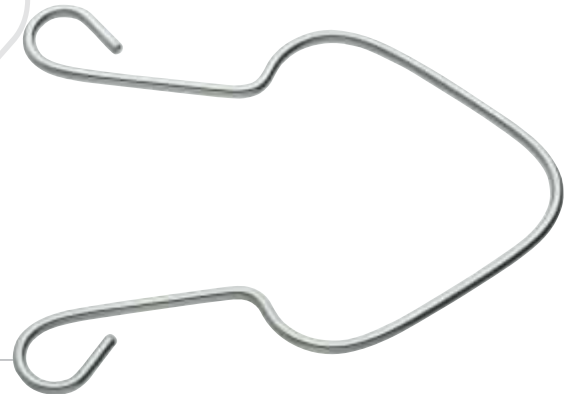

## Markers

- CT-138-20216** D'Assumpcao F/L 16.0 cm  
**CT-138-20316** 16.0 cm, with ratchet



- CT-138-20916** Pitanguy Flap Demarcator 16.0 cm, facial



- CT-138-20714** Marten Flap 14.5 cm  
**CT-138-20614** 14.5 cm, with ratchet

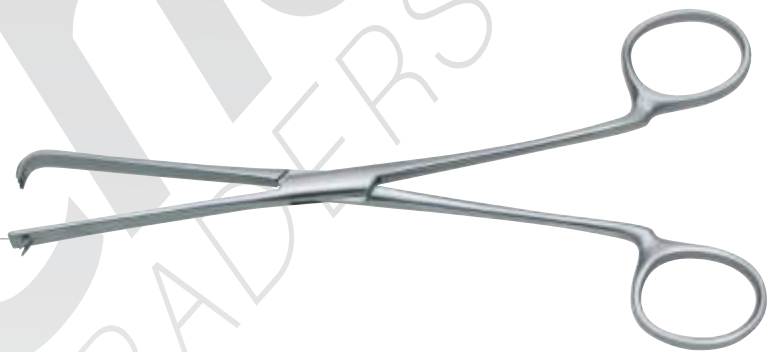

## Forceps

**Hartmann Mosquito**  
**CT-112-21010** 10.0 cm, straight  
**CT-112-21110** 10.0 cm, curved

**Halstead Mosquito**  
**CT-112-23012** 12.5 cm, straight, 1x2 teeth  
**CT-112-23112** 12.5 cm, curved, 1x2 teeth  
**CT-112-22012** 12.5 cm, straight  
**CT-112-22112** 12.5 cm, curved

**Kelly**  
**CT-112-24014** 14.0 cm, straight  
**CT-112-24114** 14.0 cm, curved

**Crile**  
hemostatic forceps  
**CT-112-25014** 14.0 cm, straight  
**CT-112-25114** 14.0 cm, curved  
**CT-112-26316** 16.0 cm, curved





## Forceps

### Rochester Pean hemostatic forceps

- CT-112-31014 14.0 cm, straight
- CT-112-31016 16.0 cm, straight
- CT-112-31020 20.0 cm, straight
- CT-112-31116 16.0 cm, curved
- CT-112-31118 18.0 cm, curved
- CT-112-31120 20.0 cm, curved

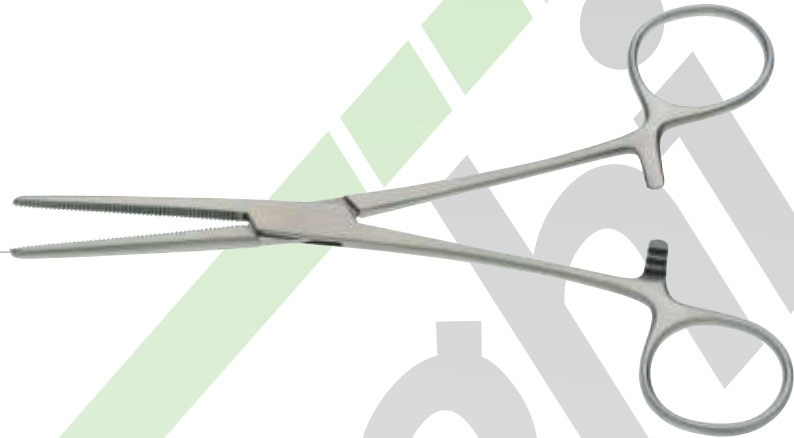

### Rochester-Ochsner hemostatic forceps

- CT-112-32014 14.0 cm, straight, 1x2 teeth
- CT-112-32114 14.0 cm, curved, 1x2 teeth
- CT-112-32016 16.0 cm, straight, 1x2 teeth
- CT-112-32116 16.0 cm, curved, 1x2 teeth

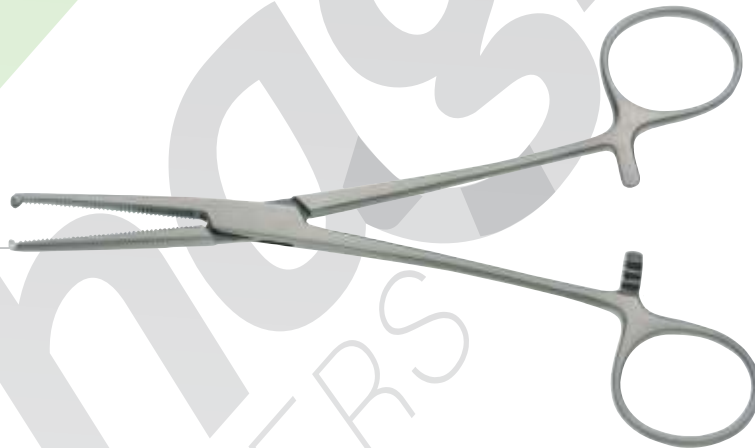

### Adson hemostatic forceps

- CT-112-41018 18.5 cm, straight
- CT-112-41118 18.5 cm, curved



## Forceps

**Lahey Vulsellum**  
**CT-154-52015** 15.0 cm  
**CT-154-52020** 20.0 cm



**Allis**  
**CT-164-10214** 14.0 cm, 4:5 teeth, Allis Baby  
**CT-164-11015** 15.0 cm, 4:5 teeth  
**CT-164-12015** 15.0 cm, 5:6 teeth  
**CT-164-12019** 19.0 cm, 5:6 teeth



**Backhaus Towel**  
**CT-114-11109** 9.0 cm  
**CT-114-11111** 11.0 cm  
**CT-114-11113** 13.0 cm  
**CT-114-11115** 15.0 cm



## Forceps

### Lorna Towel

- CT-114-12111 11.0 cm
- CT-114-12113 13.0 cm



### Jones Towel

- CT-114-10309 9.0 cm



### Foerster Sponge Holding

- CT-116-17018 18.0 cm
- CT-116-17020 20.0 cm
- CT-116-17025 25.0 cm

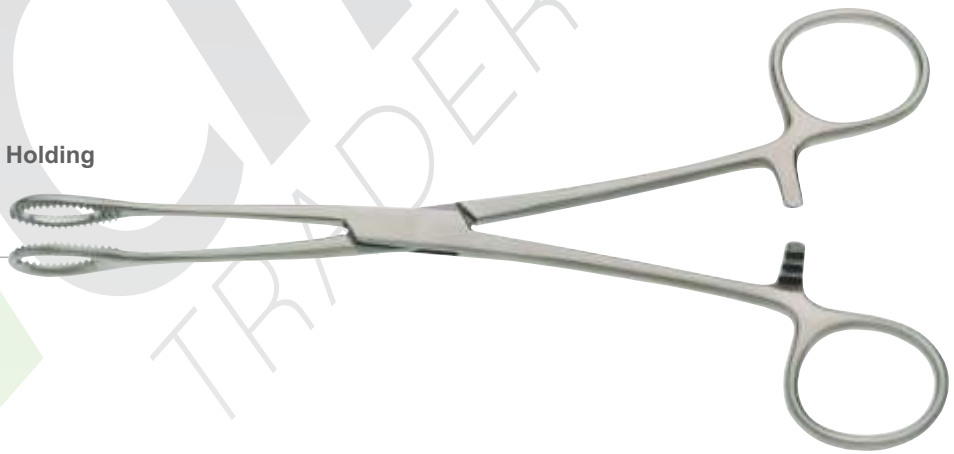

## Knives

- Ballenger Swivel**
- CT-146-39003 20.0 cm, straight, 3 mm blade
  - CT-146-39004 20.0 cm, straight, 4 mm blade
  - CT-146-39005 20.0 cm, straight, 5 mm blade
  - CT-146-39203 20.0 cm, bayonet, 3 mm blade
  - CT-146-39204 20.0 cm, bayonet, 4 mm blade
  - CT-146-39205 20.0 cm, bayonet, 5 mm blade



- Freer Mucosa Knife**
- CT-146-37415 15.0 cm, "D" pattern



- Silver Dermatome**
- CT-106-48219 19.0 cm



## Knives

### Watson Dermatome

**CT-106-48230** 30.0 cm, complete  
**CT-106-48401** spare blade (1pc.)



### Foerster

**CT-138-14027** 27.0 cm,  
capsulotomy knife



### Scalpel Handle

**CT-106-10303** 14.5 cm, Fig. 3, round



### Scalpel Handle No. 3

**CT-106-10301** 12.0 cm, with cm-graduation



**Rongeurs**

**Lempert**  
**CT-132-15016** 16.0 cm, straight  
**CT-132-15116** 16.0 cm, curved



**Beyer**  
**CT-132-20118** 18.0 cm, curved



## Bone Cutting Forceps

**CT-146-32519** **Jansen Middleton**  
nasal cutting forceps  
19.5 cm



**CT-146-21002** **Takahashi Cutting Forceps**  
11.5 cm, working length, 2.5x8 mm bite



**CT-132-28314** **Kleinert-Kutz Forceps**  
14.0 cm, straight  
**CT-132-28414** 14.0 cm, curved



## Miscellaneous

### Ruler

graduated in mm and inches

- CT-102-34010 10.0 cm
- CT-102-34020 20.0 cm
- CT-102-34030 30.0 cm
- CT-102-34050 50.0 cm



### Barron Suction Tubes

- CT-144-10103 13.0 cm, 3 french
- CT-144-10105 13.0 cm, 5 french
- CT-144-10107 13.0 cm, 7 french



### Yankauer Aspiration Tube

27.0 cm, complete with suction tip and connector

- CT-104-15027

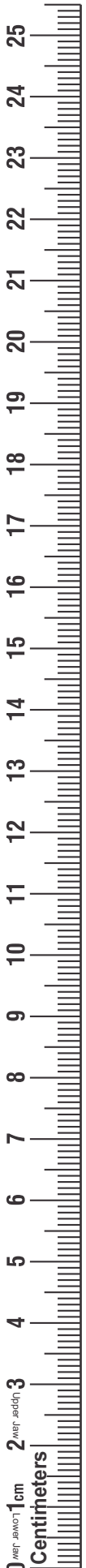
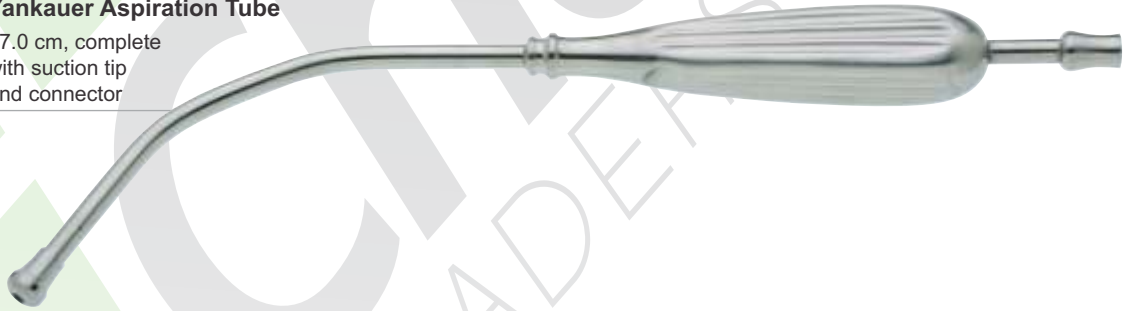



**Miscellaneous**

**CT-133-53820** **Universal Flat Nose Pliers**  
20.0 cm



**CT-133-53202** **Wire Seizing Forceps** 18.0 cm, 4 mm  
**CT-133-53203** 18.0 cm, 6 mm



**CT-133-56814** **Needle Nose Pliers**  
14.0 cm, cross-serrated



**Miscellaneous**

**General Purpose Pliers**  
18.0 cm  
**CT-133-53803**



**Wire/Pin Cutter**  
18.0 cm, 1.7 wire, TC  
22.0 cm, 2.5 wire, TC  
**CT-133-54717**  
**CT-133-54522**



**Wire/Pin Cutter**  
18.0 cm, TC  
**CT-133-54618**



## Cannulas / Lipo Suction

### Lipo Hand piece

with lever mechanism,  
quick lock mechanism

CT-138-40010

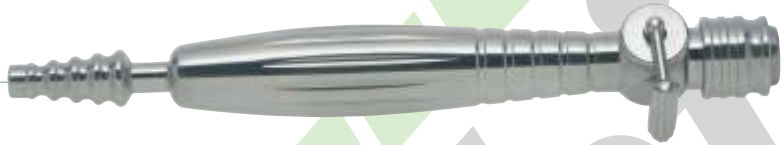

with thumb control,  
quick lock mechanism

CT-138-40020



### Triport

working length    Ø

CT-138-41315	150 mm	3 mm
CT-138-41320	200 mm	3 mm
CT-138-41325	250 mm	3 mm
CT-138-41330	300 mm	3 mm
CT-138-41420	200 mm	4 mm
CT-138-41425	250 mm	4 mm
CT-138-41430	300 mm	4 mm
CT-138-41525	250 mm	5 mm
CT-138-41530	300 mm	5 mm



### Monoport

working length    Ø

CT-138-42315	150 mm	3 mm
CT-138-42320	200 mm	3 mm
CT-138-42325	250 mm	3 mm
CT-138-42330	300 mm	3 mm
CT-138-42420	200 mm	4 mm
CT-138-42425	250 mm	4 mm
CT-138-42430	300 mm	4 mm
CT-138-42525	250 mm	5 mm
CT-138-42530	300 mm	5 mm



## Cannulas / Lipo Suction

<b>Cobra</b>		
	working length	Ø
CT-138-43315	150 mm	3 mm
CT-138-43320	200 mm	3 mm
CT-138-43325	250 mm	3 mm
CT-138-43420	200 mm	4 mm
CT-138-43425	250 mm	4 mm
CT-138-43430	300 mm	4 mm
CT-138-43525	250 mm	5 mm
CT-138-43530	300 mm	5 mm



<b>Spirale</b>		
	working length	Ø
CT-138-44315	150 mm	3 mm
CT-138-44320	200 mm	3 mm
CT-138-44325	250 mm	3 mm
CT-138-44420	200 mm	4 mm
CT-138-44425	250 mm	4 mm
CT-138-44430	300 mm	4 mm
CT-138-44525	250 mm	5 mm
CT-138-44530	300 mm	5 mm



<b>Shark</b>		
	working length	Ø
CT-138-45315	150 mm	3 mm
CT-138-45320	200 mm	3 mm
CT-138-45325	250 mm	3 mm
CT-138-45420	200 mm	4 mm
CT-138-45425	250 mm	4 mm
CT-138-45430	300 mm	4 mm
CT-138-45525	250 mm	5 mm
CT-138-45530	300 mm	5 mm



## Cannulas / Lipo Suction

### Lipo Hand piece

with thumb control,  
luer lock

CT-138-40030



### Triport

working length    Ø

CT-138-46320	200 mm	3 mm
CT-138-46325	250 mm	3 mm
CT-138-46420	200 mm	4 mm
CT-138-46425	250 mm	4 mm
CT-138-46430	300 mm	4 mm
CT-138-46525	250 mm	5 mm
CT-138-46530	300 mm	5 mm



### Mercedes

working length    Ø

CT-138-47320	200 mm	3 mm
CT-138-47325	250 mm	3 mm
CT-138-47420	200 mm	4 mm
CT-138-47425	250 mm	4 mm
CT-138-47430	300 mm	4 mm
CT-138-47525	250 mm	5 mm
CT-138-47530	300 mm	5 mm



### Spirale

working length    Ø

CT-138-48320	200 mm	3 mm
CT-138-48325	250 mm	3 mm
CT-138-48420	200 mm	4 mm
CT-138-48425	250 mm	4 mm
CT-138-48430	300 mm	4 mm
CT-138-48525	250 mm	5 mm
CT-138-48530	300 mm	5 mm



## Order Number Index

art.-no.	page	art.-no.	page	art.-no.	page	art.-no.	page	art.-no.	page
CT-102-31710	70	CT-108-21220	4	CT-108-28615	13	CT-108-39518	10	CT-110-18805	29
CT-102-31811	70	CT-108-21320	4	CT-108-28618	13	CT-108-40118	10	CT-110-18812	29
CT-102-31911	70	CT-108-21420	4	CT-108-28620	13	CT-108-40213	11	CT-110-18851	30
CT-102-34010	82	CT-108-21518	4	CT-108-28623	13	CT-108-40354	11	CT-110-20012	30
CT-102-34020	82	CT-108-21520	4	CT-108-28628	13	CT-108-40716	11	CT-110-20412	28
CT-102-34030	82	CT-108-21523	4	CT-108-28715	13	CT-108-53916	9	CT-110-20512	28
CT-102-34050	82	CT-108-21617	17	CT-108-28718	13	CT-108-80209	16	CT-110-22217	32
CT-104-15027	82	CT-108-21620	4	CT-108-28720	13	CT-108-82313	6	CT-110-22417	32
CT-106-10301	79	CT-108-21720	4	CT-108-28723	13	CT-108-83512	15	CT-110-22517	32
CT-106-10303	79	CT-108-21818	6	CT-108-28728	13	CT-108-90114	17	CT-110-22618	32
CT-106-48219	78	CT-108-21820	6	CT-108-30414	9	CT-108-90118	17	CT-110-25317	32
CT-106-48230	79	CT-108-21918	4	CT-108-30454	9	CT-108-93114	16	CT-110-25815	31
CT-106-48401	79	CT-108-22018	4	CT-108-30514	9	CT-109-20615	17	CT-110-26915	31
CT-107-17017	14	CT-108-22417	5	CT-108-30554	9	CT-109-20618	17	CT-110-27215	31
CT-107-17117	14	CT-108-22419	5	CT-108-30612	9	CT-109-20715	17	CT-110-30118	33
CT-107-28015	12	CT-108-22517	5	CT-108-31212	8	CT-109-20718	17	CT-110-30618	33
CT-107-28018	12	CT-108-22519	5	CT-108-31412	8	CT-109-20815	17	CT-110-32323	33
CT-107-28023	12	CT-108-23312	5	CT-108-32209	16	CT-109-20818	17	CT-110-33010	35
CT-107-28115	12	CT-108-23315	5	CT-108-32309	16	CT-109-20915	17	CT-110-33012	35
CT-107-28118	12	CT-108-23323	5	CT-108-32610	16	CT-109-20918	17	CT-110-33100	35
CT-107-28123	12	CT-108-24018	6	CT-108-32710	16	CT-110-11115	31	CT-110-33112	35
CT-107-37411	8	CT-108-24516	5	CT-108-34011	8	CT-110-11618	32	CT-110-33201	35
CT-107-37511	8	CT-108-24520	5	CT-108-34111	8	CT-110-11621	32	CT-110-33204	35
CT-108-10614	15	CT-108-24816	6	CT-108-34211	8	CT-110-11625	32	CT-110-33205	35
CT-108-10714	15	CT-108-27415	13	CT-108-34251	8	CT-110-16912	29	CT-110-33225	35
CT-108-11214	14	CT-108-27418	13	CT-108-34311	8	CT-110-17012	28	CT-110-33503	35
CT-108-11314	14	CT-108-27423	13	CT-108-34351	8	CT-110-17312	29	CT-110-33504	35
CT-108-12214	15	CT-108-27515	13	CT-108-34411	8	CT-110-17315	29	CT-110-33505	35
CT-108-12314	15	CT-108-27518	13	CT-108-34511	8	CT-110-17412	28	CT-110-33507	35
CT-108-17415	13	CT-108-27523	13	CT-108-35010	10	CT-110-17415	28	CT-110-33515	35
CT-108-17417	13	CT-108-28415	12	CT-108-36011	7	CT-110-17452	29	CT-110-33525	35
CT-108-17515	13	CT-108-28418	12	CT-108-36051	7	CT-110-17455	29	CT-111-10415	35
CT-108-17517	13	CT-108-28420	12	CT-108-36111	7	CT-110-17512	28	CT-111-10515	35
CT-108-19421	14	CT-108-28423	12	CT-108-36151	7	CT-110-17515	28	CT-111-10818	35
CT-108-19521	14	CT-108-28428	12	CT-108-36211	7	CT-110-17612	28	CT-111-10918	35
CT-108-20512	16	CT-108-28515	12	CT-108-36311	7	CT-110-17912	28	CT-111-30015	33
CT-108-20514	16	CT-108-28518	12	CT-108-36509	15	CT-110-18012	28	CT-111-30020	33
CT-108-20911	7	CT-108-28520	12	CT-108-36512	15	CT-110-18512	29	CT-111-30024	33
CT-108-20914	7	CT-108-28523	12	CT-108-37411	8	CT-110-18612D	29	CT-111-30315	33
CT-108-21011	7	CT-108-28528	12	CT-108-37511	8	CT-110-18802	29	CT-111-30320	33



## Order Number Index

art.-no.	page	art.-no.	page	art.-no.	page	art.-no.	page	art.-no.	page
CT-111-30324	33	CT-114-11113	76	CT-118-25222	45	CT-118-65010	43	CT-124-24817	21
CT-111-30416	33	CT-114-11115	76	CT-118-25238	45	CT-118-67014	43	CT-124-24819	21
CT-111-30420	33	CT-114-12111	77	CT-118-25318	46	CT-118-80120	48	CT-124-41414	23
CT-111-30424	33	CT-114-12113	77	CT-118-25438	47	CT-118-80121	48	CT-124-41418	23
CT-111-30430	33	CT-116-17018	77	CT-118-25615	46	CT-122-32014	75	CT-124-43416	23
CT-111-30616	33	CT-116-17020	77	CT-118-26513	47	CT-122-32114	75	CT-124-63414	25
CT-111-30620	33	CT-116-17025	77	CT-118-55080	40	CT-124-11012	19	CT-124-63415	25
CT-111-30624	33	CT-118-13121	45	CT-118-55090	40	CT-124-11412	19	CT-124-63418	25
CT-111-30816	33	CT-118-16017	48	CT-118-55092	40	CT-124-12811	18	CT-124-63514	25
CT-111-30820	33	CT-118-16117	48	CT-118-55100	40	CT-124-12913	18	CT-124-63515	25
CT-111-30824	33	CT-118-17731	43	CT-118-55120	40	CT-124-13413	18	CT-124-63518	25
CT-111-30830	33	CT-118-17925	41	CT-118-55122	40	CT-124-14011	18	CT-124-63614	25
CT-111-31016	33	CT-118-19516	44	CT-118-55150	40	CT-124-14013	18	CT-124-63615	25
CT-111-31020	33	CT-118-19612	41	CT-118-55152	40	CT-124-14413	18	CT-124-63618	25
CT-111-31024	33	CT-118-19625	41	CT-118-55154	40	CT-124-14713	19	CT-124-63714	25
CT-111-31030	33	CT-118-20413	69	CT-118-55170	40	CT-124-15412	22	CT-124-63715	25
CT-112-21010	74	CT-118-20501	68	CT-118-55190	40	CT-124-15414	22	CT-124-63718	25
CT-112-21110	74	CT-118-20503	68	CT-118-55480	40	CT-124-16215	21	CT-124-64014	24
CT-112-22012	74	CT-118-20803	68	CT-118-55490	40	CT-124-16415	21	CT-124-64015	24
CT-112-22112	74	CT-118-20805	68	CT-118-55492	40	CT-124-16418	21	CT-124-64018	24
CT-112-23012	74	CT-118-20807	68	CT-118-55500	40	CT-124-16420	21	CT-124-64114	24
CT-112-23112	74	CT-118-20913	68	CT-118-55520	40	CT-124-16423	21	CT-124-64115	24
CT-112-24014	74	CT-118-21201	69	CT-118-55522	40	CT-124-18414	22	CT-124-64118	24
CT-112-24114	74	CT-118-21202	69	CT-118-55550	40	CT-124-18416	22	CT-124-64214	24
CT-112-25014	74	CT-118-21413	68	CT-118-55552	40	CT-124-18418	22	CT-124-64215	24
CT-112-25114	74	CT-118-21418	68	CT-118-55554	40	CT-124-18420	22	CT-124-64218	24
CT-112-26316	74	CT-118-21601	68	CT-118-55570	40	CT-124-21815	19	CT-124-64314	24
CT-112-31014	75	CT-118-21602	68	CT-118-55590	40	CT-124-22413	20	CT-124-64315	24
CT-112-31016	75	CT-118-21605	68	CT-118-56019	41	CT-124-22415	20	CT-124-64318	24
CT-112-31020	75	CT-118-21607	68	CT-118-56112	40	CT-124-22418	20	CT-124-65712	27
CT-112-31116	75	CT-118-21610	68	CT-118-57001	42	CT-124-22613	20	CT-124-65912	27
CT-112-31118	75	CT-118-23908	49	CT-118-57002	42	CT-124-22615	20	CT-124-66614	26
CT-112-31120	75	CT-118-23914	49	CT-118-57011	42	CT-124-22618	20	CT-124-66615	26
CT-112-32016	75	CT-118-24214	47	CT-118-57012	42	CT-124-23415	21	CT-124-66618	26
CT-112-32116	75	CT-118-24314	47	CT-118-57021	42	CT-124-23418	21	CT-124-66714	26
CT-112-41018	75	CT-118-24316	49	CT-118-57022	42	CT-124-23814	20	CT-124-66715	26
CT-112-41118	75	CT-118-24911	45	CT-118-63410	48	CT-124-23815	20	CT-124-66718	26
CT-114-10309	77	CT-118-25011	45	CT-118-63510	48	CT-124-23818	20	CT-124-66814	26
CT-114-11109	76	CT-118-25122	45	CT-118-63610	48	CT-124-23820	20	CT-124-66815	26
CT-114-11111	76	CT-118-25138	45	CT-118-63710	48	CT-124-24814	21	CT-124-66818	26



## Order Number Index

art.-no.	page	art.-no.	page	art.-no.	page	art.-no.	page	art.-no.	page
CT-124-66914	26	CT-133-53820	83	CT-138-30233	52	CT-138-32115	56	CT-138-44325	86
CT-124-66915	26	CT-133-53901	23	CT-138-30242	52	CT-138-33001	57	CT-138-44420	86
CT-124-66918	26	CT-133-53902	23	CT-138-30333	52	CT-138-33002	57	CT-138-44425	86
CT-124-67513	26	CT-133-53903	23	CT-138-30342	52	CT-138-33123	57	CT-138-44430	86
CT-124-67514	26	CT-133-54522	84	CT-138-31133	53	CT-138-33501	57	CT-138-44525	86
CT-124-67517	26	CT-133-54618	84	CT-138-31142	53	CT-138-33502	57	CT-138-44530	86
CT-124-67518	26	CT-133-54717	84	CT-138-31233	53	CT-138-34001	57	CT-138-45315	86
CT-124-67813	26	CT-133-56814	83	CT-138-31242	53	CT-138-35023	57	CT-138-45320	86
CT-124-67814	26	CT-133-60001	22	CT-138-31333	53	CT-138-40010	85	CT-138-45325	86
CT-124-67817	26	CT-133-60002	22	CT-138-31342	53	CT-138-40020	87	CT-138-45420	86
CT-124-67819	26	CT-133-60011	22	CT-138-31432	53	CT-138-41315	85	CT-138-45425	86
CT-124-69614	27	CT-133-60012	22	CT-138-32001	54	CT-138-41320	85	CT-138-45430	86
CT-124-69618	27	CT-138-10400	72	CT-138-32002	54	CT-138-41325	85	CT-138-45525	86
CT-124-69714	27	CT-138-10534	72	CT-138-32003	54	CT-138-41330	85	CT-138-45530	86
CT-124-69718	27	CT-138-10536	72	CT-138-32004	54	CT-138-41420	85	CT-138-46320	87
CT-124-69814	27	CT-138-10538	72	CT-138-32005	54	CT-138-41425	85	CT-138-46325	87
CT-124-69818	27	CT-138-10542	72	CT-138-32006	55	CT-138-41430	85	CT-138-46420	87
CT-124-69914	27	CT-138-10545	72	CT-138-32007	55	CT-138-41525	85	H138-46425	87
CT-124-69918	27	CT-138-10550	72	CT-138-32008	55	CT-138-41530	85	H138-46430	87
CT-124-70214	27	CT-138-10738	72	CT-138-32009	55	CT-138-42315	85	H138-46525	87
CT-124-70218	27	CT-138-10742	72	CT-138-32011	54	CT-138-42320	85	H138-46530	87
CT-128-41001	39	CT-138-11038	72	CT-138-32012	54	CT-138-42325	85	H138-47320	87
CT-132-15016	80	CT-138-11042	72	CT-138-32013	54	CT-138-42330	85	H138-47325	87
CT-132-15116	80	CT-138-11045	72	CT-138-32014	54	CT-138-42420	85	H138-47420	87
CT-132-20118	80	CT-138-11414	72	CT-138-32015	54	CT-138-42425	85	H138-47425	87
CT-132-28314	81	CT-138-11416	72	CT-138-32016	55	CT-138-42430	85	H138-47430	87
CT-132-28414	81	CT-138-14027	79	CT-138-32017	55	CT-138-42525	85	H138-47525	87
CT-132-45001	51	CT-138-15030	71	CT-138-32018	55	CT-138-42530	85	H138-47530	87
CT-132-45002	51	CT-138-15041	71	CT-138-32019	55	CT-138-43315	86	H138-48320	87
CT-132-68625	61	CT-138-15536	71	CT-138-32101	55	CT-138-43320	86	H138-48325	87
CT-132-69114	61	CT-138-16033	71	CT-138-32102	56	CT-138-43325	86	H138-48420	87
CT-132-69214	61	CT-138-20216	73	CT-138-32103	56	CT-138-43420	86	H138-48425	87
CT-132-69632	61	CT-138-20316	73	CT-138-32104	56	CT-138-43425	86	H138-48430	87
CT-132-69702	61	CT-138-20614	73	CT-138-32105	56	CT-138-43430	86	H138-48525	87
CT-132-81921	65	CT-138-20714	73	H138-32111	55	H138-43525	86	H138-48530	87
CT-133-53202	83	CT-138-20916	73	H138-32112	56	H138-43530	86	H142-37613	47
CT-133-53203	83	CT-138-30133	52	H138-32113	56	H138-44315	86	H142-58307	70
CT-133-53803	84	CT-138-30142	52	H138-32114	56	H138-44320	86	H142-81010	30





## Order Number Index

art.-no.	page	art.-no.	page	art.-no.	page	art.-no.	page	art.-no.	page
CT-142-82010	30	CT-146-37415	78	CT-146-47103	59	CT-146-52401	38	CT-148-56600	67
CT-142-82511	30	CT-146-39003	78	CT-146-47104	59	CT-146-52402	38	CT-148-57215	50
CT-142-94004	31	CT-146-39004	78	CT-146-47105	59	CT-146-52521	39	CT-148-57701	50
CT-142-94006	31	CT-146-39005	78	CT-146-47106	59	CT-146-53018	36	CT-148-58500	67
CT-143-07605	31	CT-146-39203	78	CT-146-47107	59	CT-146-53101	37	CT-148-58716	49
CT-143-07610	31	CT-146-39204	78	CT-146-47108	59	CT-146-53102	37	CT-148-69907	67
CT-143-07612	31	CT-146-39205	78	CT-146-47109	59	CT-146-53103	37	CT-148-69911	67
CT-143-07805	31	CT-146-40119	65	CT-146-47110	59	CT-146-53219	63	CT-148-90301	49
CT-143-07810	31	CT-146-40418	66	CT-146-47111	59	CT-146-53419	63	CT-148-90416	50
CT-143-07812	31	CT-146-41645	66	CT-146-47112	59	CT-146-53800	62	CT-154-52015	76
CT-143-14903	30	CT-146-41665	66	CT-146-47115	59	CT-146-54105	42	CT-154-52020	76
CT-143-14905	30	CT-146-42123	65	CT-146-47210	60	CT-146-54125	42	CT-164-10214	76
CT-143-14909	30	CT-146-42516	65	CT-146-47212	60	CT-146-54516	43	CT-164-11015	76
CT-143-14915	30	CT-146-42519	66	CT-146-47214	60	CT-146-54615	50	CT-164-12015	76
CT-144-10103	82	CT-146-43124	65	CT-146-47216	60	CT-146-55116	42	CT-164-12019	76
CT-144-10105	82	CT-146-43317	66	CT-146-47301	58	CT-146-55126	42	CT-174-12803	63
CT-144-10107	82	CT-146-44710	60	CT-146-47302	58	CT-146-55218	69	CT-174-12804	63
CT-144-20614	34	CT-146-44720	60	CT-146-47303	58	CT-146-55412	44	CT-174-12805	63
CT-144-20616	34	CT-146-44802	58	CT-146-47518	59	CT-146-55508	43	CT-182-89501	36
CT-144-76321	63	CT-146-44803	58	CT-146-47701	58	CT-146-55511	44	CT-182-89502	36
CT-146-11201	64	CT-146-45004	60	CT-146-47702	58	CT-146-55614	44	CT-182-89503	36
CT-146-11202	64	CT-146-46307	58	CT-146-47918	60	CT-146-55616	44	CT-182-89504	36
CT-146-11203	64	CT-146-46317	58	CT-146-50318	66	CT-146-55701	69	CT-182-89505	36
CT-146-12035	64	CT-146-46327	58	CT-146-50501	36	CT-146-55702	69		
CT-146-12050	64	CT-146-46702	59	CT-146-50604	37	CT-146-55703	69		
CT-146-12075	64	CT-146-46703	59	CT-146-50605	37	CT-146-55920	42		
CT-146-12090	64	CT-146-46704	59	CT-146-50608	37	CT-146-56018	69		
CT-146-12435	64	CT-146-46705	59	CT-146-50919	36	CT-146-56218	69		
CT-146-12450	64	CT-146-46706	59	CT-146-50920	36	CT-146-56502	46		
CT-146-12475	64	CT-146-46709	59	CT-146-51022	38	CT-146-56614	69		
CT-146-12490	64	CT-146-46710	59	CT-146-51916	37	CT-146-56810	50		
CT-146-15420	34	CT-146-46810	60	CT-146-52101	39	CT-146-57123	63		
CT-146-21002	81	CT-146-46814	60	CT-146-52102	39	CT-146-57223	63		
CT-146-25318	62	CT-146-46816	60	CT-146-52201	36	CT-146-57323	63		
CT-146-25520	62	CT-146-46907	58	CT-146-52203	36	CT-146-57523	63		
CT-146-26120	12	CT-146-46917	58	CT-146-52205	36	CT-146-57719	67		
CT-146-26122	12	CT-146-46927	58	CT-146-52207	36	CT-148-32400	51		
CT-146-32519	81	CT-146-47102	59	CT-146-52321	38	CT-148-56411	40		





## Contact Us



Email : [info@chaghitraders.com](mailto:info@chaghitraders.com)



Website: [www.chaghitraders.com](http://www.chaghitraders.com)



Mobile & Whatsapp: 0092 333 1277 676



Address: New Miana Pura West, Near Islamic Road, Eid Gah Chowk, Sialkot , 51310, Pakistan.