

SPINAL RETRACTOR
SYSTEMS

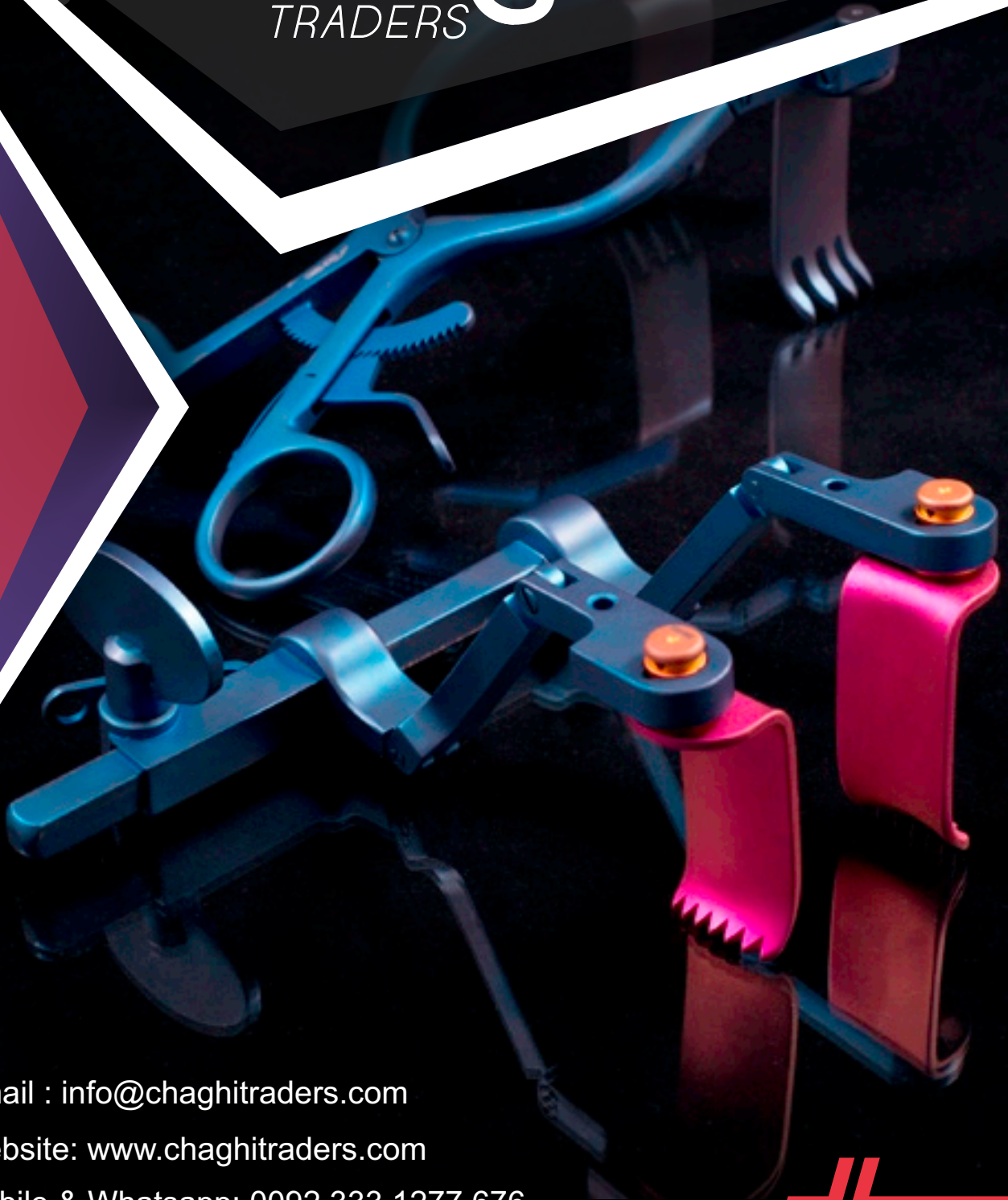

Email : info@chaghitraders.com



Website: www.chaghitraders.com



Mobile & Whatsapp: 0092 333 1277 676



New Miana Pura West, Near Islamic Road,
Eid Gha Chowk, Sialkot, 51310, Pakistan

Caspar Cervical Vertebral Retractor Frame

Accommodates all blade types / single articulation / 85 mm
maximum spread / 6 1/2" (16.5 cm)

CT-416-280 stainless steel
CT-416-680 titanium



Caspar Cervical Vertebral Retractor Frame

Accommodates all blade types / double articulation / 125 mm
maximum spread / 8" (20 cm)

CT-416-260 stainless steel
CT-416-660 titanium

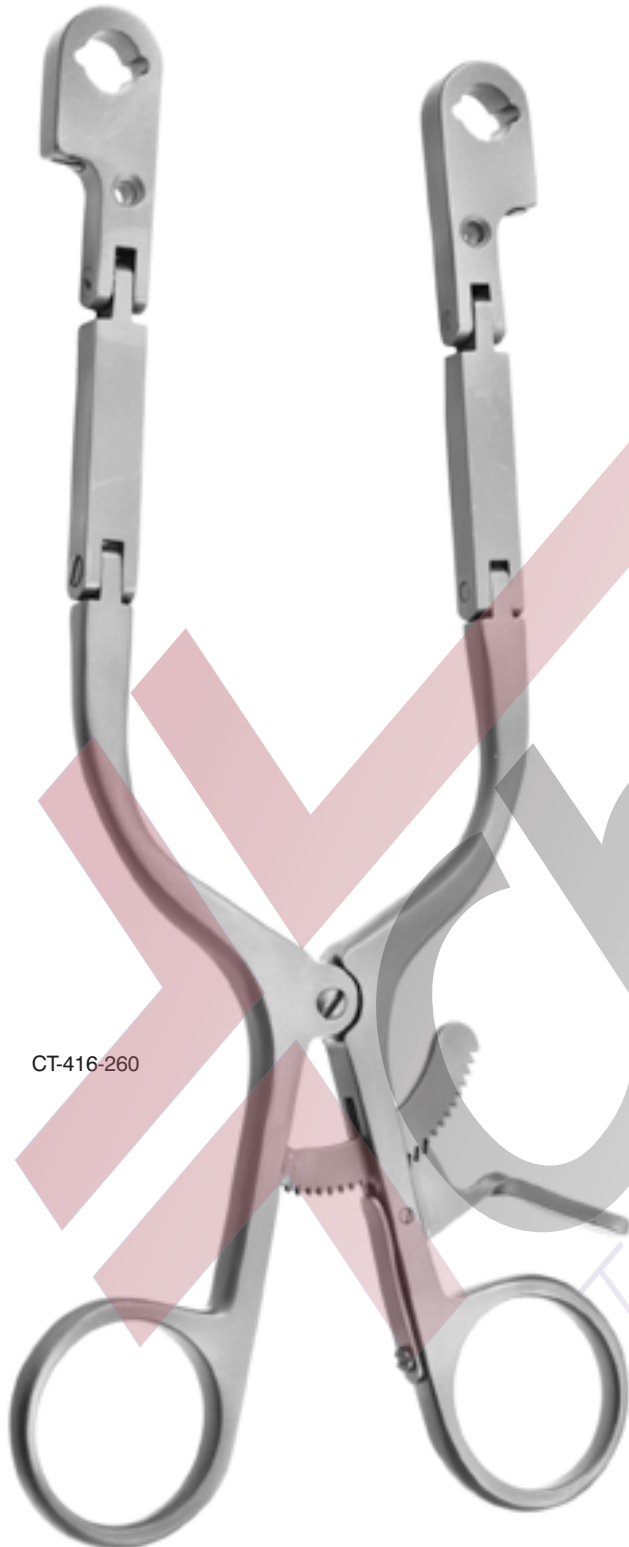

Caspar Cervical Vertebral Retractor Frame

Accommodates all blade types / single articulation / V-handle /
85 mm maximum spread

CT-416-230 4 1/2" (11.5 cm)

Caspar Cervical Vertebral Retractor Frame

For use with the titanium & plastic quick release blades only /
double articulation / 100 mm maximum spread

CT-416-250 6 1/4" (16 cm)



Caspar MIS Cervical Vertebral Column Retractor Frame

Accommodates all blade types / double articulation / 90 mm maximum spread

CT-416-200 stainless steel

CT-416-700 titanium

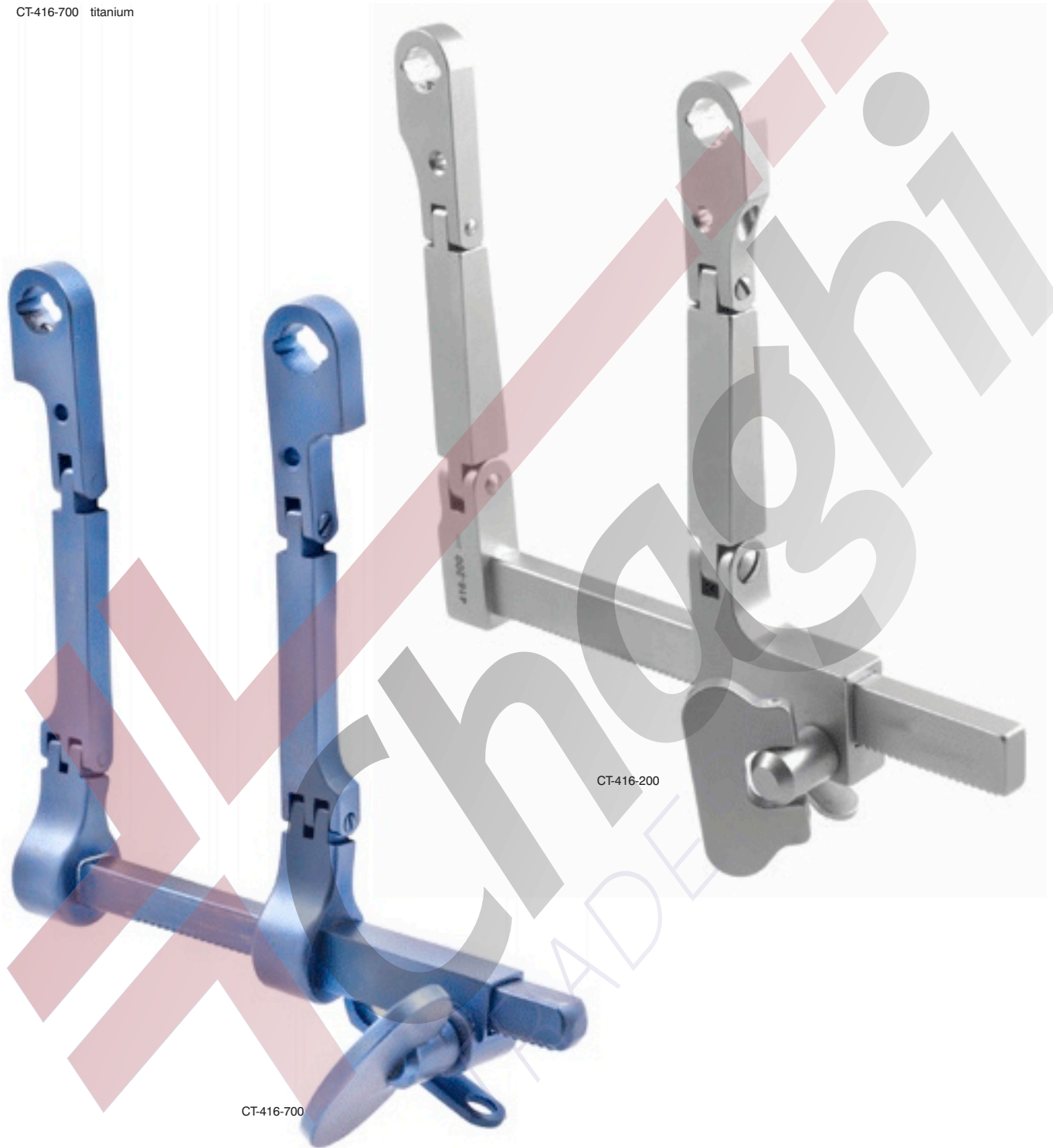

Caspar Cervical Vertebral Column Retractor Frame

Rotatable arms / accommodates all blade types / double articulation / 90 mm maximum spread

CT-416-202 stainless steel

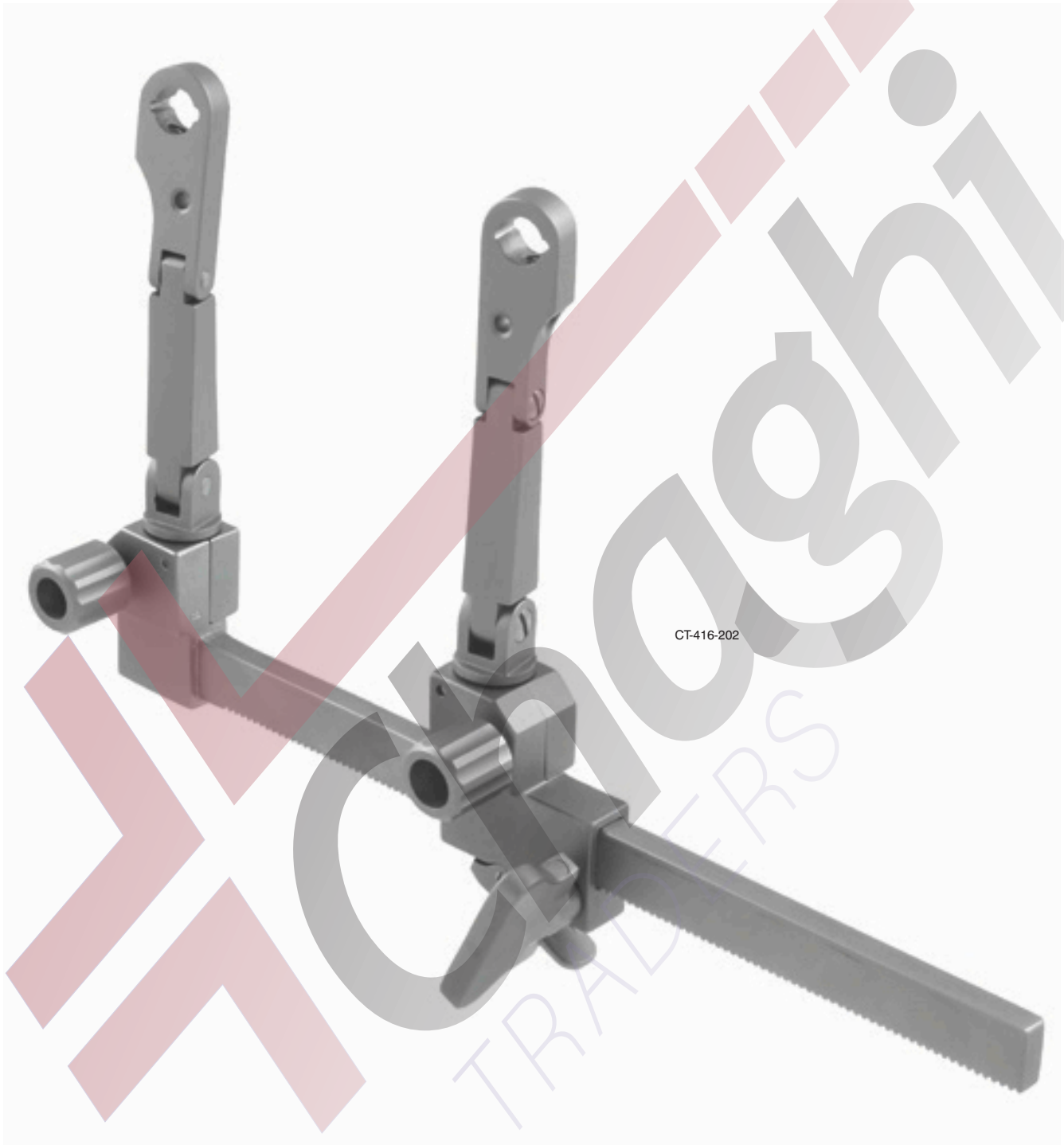

Caspar V-Blunt Blade

Stainless steel

CT-416-450	45 x 20 mm
CT-416-452	50 x 20 mm
CT-416-454	55 x 20 mm
CT-416-456	60 x 20 mm
CT-416-458	65 x 20 mm

Plastic / quick release / ultra-transparent to X-ray

CT-416-460	45 x 20 mm
CT-416-462	50 x 20 mm
CT-416-464	55 x 20 mm
CT-416-466	60 x 20 mm
CT-416-468	65 x 20 mm

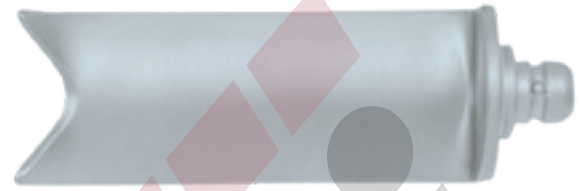

Stainless steel



Plastic / quick release

Caspar Serrated Lateral Blade

Stainless steel

CT-416-520	45 x 20 mm
CT-416-522	50 x 20 mm
CT-416-524	55 x 20 mm
CT-416-526	60 x 20 mm
CT-416-528	65 x 20 mm

Anodized aluminum

CT-416-510	45 x 20 mm
CT-416-512	50 x 20 mm
CT-416-514	55 x 20 mm
CT-416-516	60 x 20 mm
CT-416-518	65 x 20 mm

Plastic / quick release

CT-416-530	45 x 20 mm
CT-416-532	50 x 20 mm
CT-416-534	55 x 20 mm
CT-416-536	60 x 20 mm
CT-416-538	65 x 20 mm

Titanium / quick release / semi-transparent to X-ray

CT-416-500	45 x 22 mm
CT-416-502	50 x 22 mm
CT-416-504	55 x 22 mm
CT-416-506	60 x 22 mm
CT-416-508	65 x 22 mm



Titanium / quick release



Plastic / quick release

Caspar Blunt Smooth Blade

Anodized aluminum

CT-416-560	45 x 20 mm
CT-416-562	50 x 20 mm
CT-416-564	55 x 20 mm
CT-416-566	60 x 20 mm
CT-416-568	65 x 20 mm

Titanium / quick release / semi-transparent to X-ray

CT-416-550	45 x 20 mm
CT-416-552	50 x 20 mm
CT-416-554	55 x 20 mm
CT-416-556	60 x 20 mm
CT-416-558	65 x 20 mm
CT-416-559	75 x 20 mm



Anodized titanium



Titanium / quick release

Medial Blade

Stainless steel

CT-416-400	45 x 20 mm
CT-416-402	50 x 20 mm
CT-416-404	55 x 20 mm
CT-416-406	60 x 20 mm
CT-416-408	65 x 20 mm

Anodized aluminum / special order only

CT-416-410	45 x 20 mm
CT-416-412	50 x 20 mm
CT-416-414	55 x 20 mm
CT-416-416	60 x 20 mm
CT-416-418	65 x 20 mm

Plastic / quick release / ultra-transparent to X-ray

CT-416-420	45 x 20 mm
CT-416-422	50 x 20 mm
CT-416-424	55 x 20 mm
CT-416-426	60 x 20 mm
CT-416-428	65 x 20 mm



Aluminum

Caspar Blade Removal Forceps

For changing blades

CT-416-298	straight
CT-416-299	angled



CT-416-298



CT-416-299

Caspar Hand Universal Retractor

For use with the quick release blades only / with depth gauge / screw on blade lock (more secure hold)

CT-416-220 8" (20 cm)

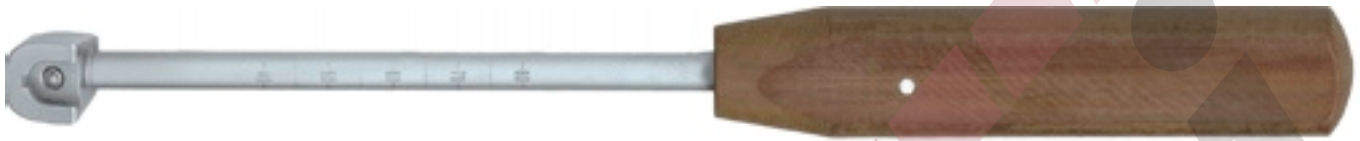

CT-416-220

For use with the quick release blades only / black handle

CT-416-220L snap lock 8" (20 cm)

CT-416-220B screw on blade lock 7 1/4" (18.4 cm)



CT-416-220B



CT-416-220L

Caspar Cervical Vertebral Column Quick Release Retractor Frame

Accommodates SL-Connect blades / double articulation / 90 mm maximum spread / quick release

CT-416-650

CT-416-655 trans-verse/stepdown

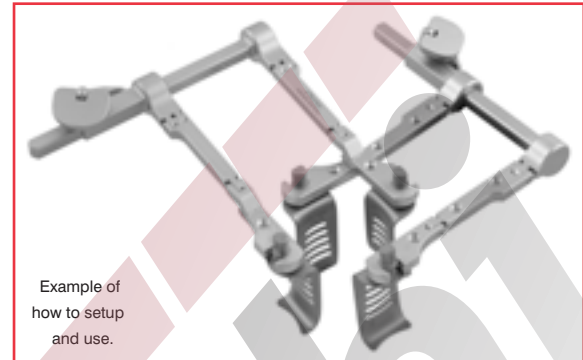

CT-416-650

CT-416-655

SL - Connect Blade Insert Instrument

7 1/4" (18m mm)

CT-416-225



CT-416-225

SL - Connect Lateral Blade Titanium

Quick release

CT-416-580 24 x 45

CT-416-582 24 x 50

CT-416-584 24 x 55

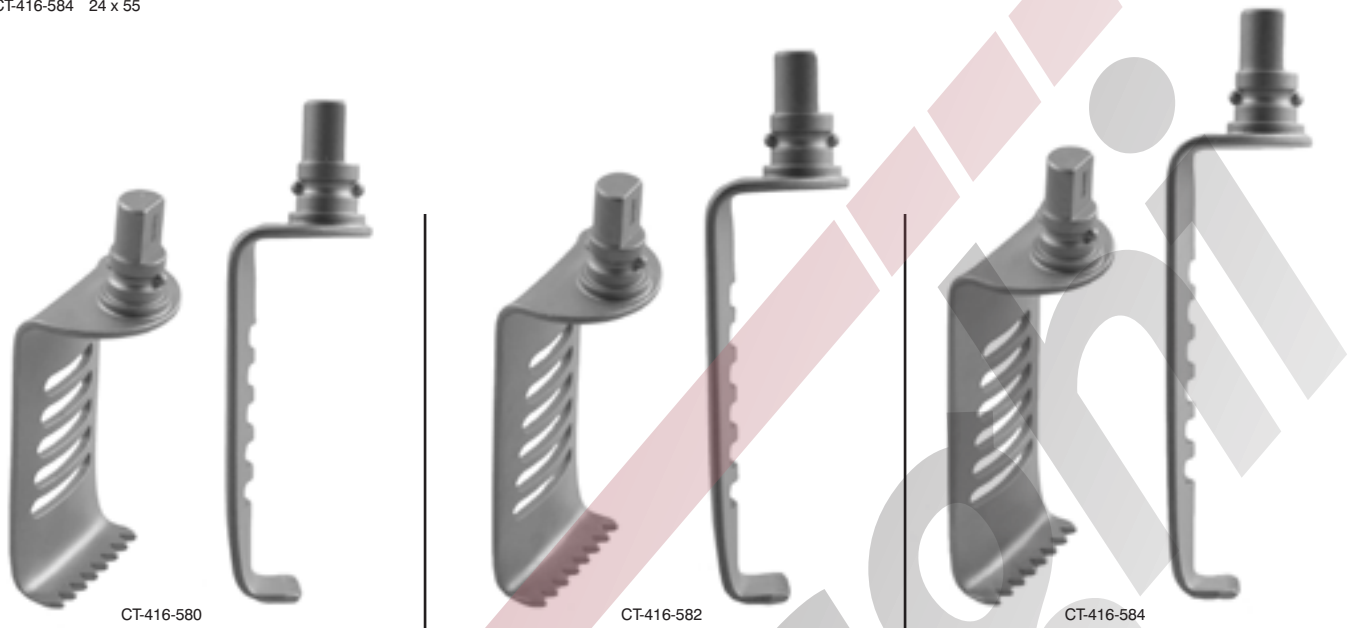

SL - Connect Blunt Blade Titanium

Quick release

CT-416-586 24 x 45

CT-416-588 24 x 50

CT-416-590 24 x 55



Caspar Distractor Vertebral Retractor

CT-416-300 right
CT-416-305 left



Caspar Drill Guide

Works in conjunction with distractors pictured on previous page. Screw mechanism slides over distractor bar for drill guide.

CT-416-340 right
CT-416-342 left

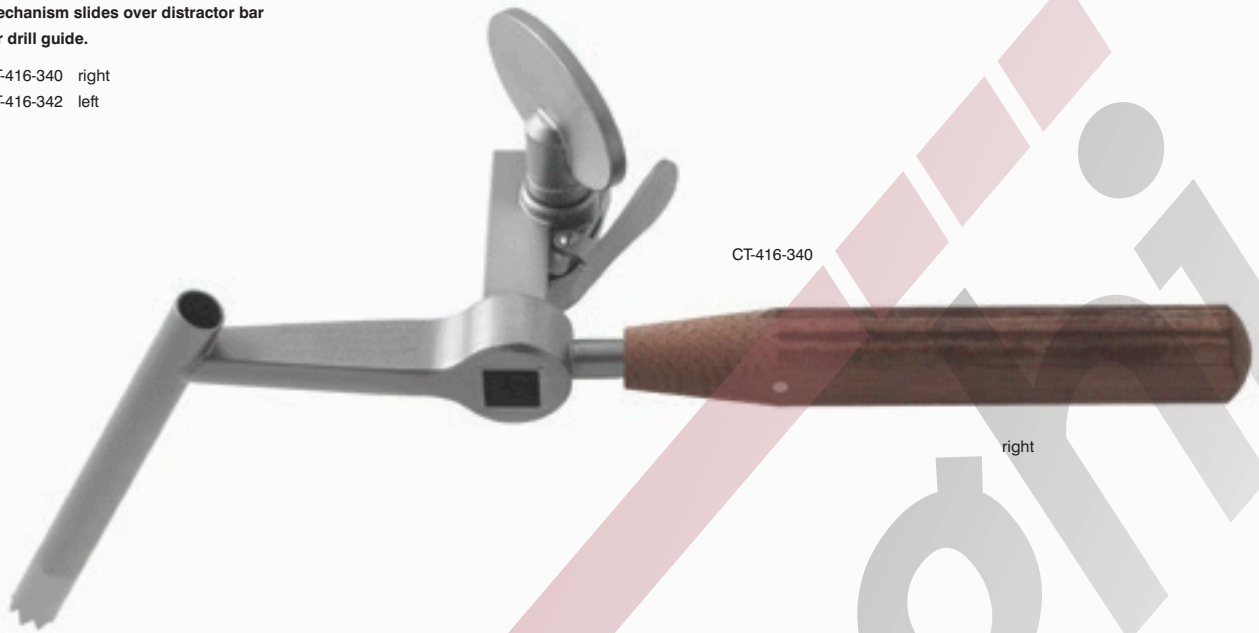

right

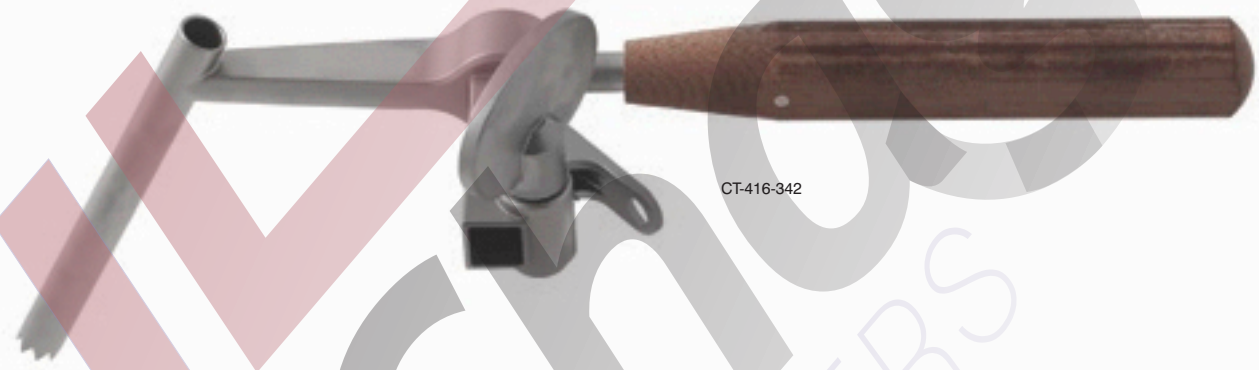

left



Caspar Twist Drill

CT-416-335 1.7 mm Ø



Caspar Screw Post

For Distractor

CT-416-312 12 mm

CT-416-314 14 mm

CT-416-316 16 mm

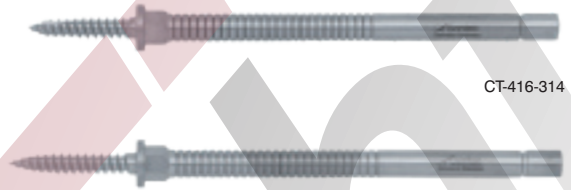

CT-416-314

CT-416-316

Caspar Screwdriver

For Distractor / also available
in phenolic plastic handle

CT-416-330



Caspar Lumbar Speculum

Non-reflective / anodized surface / 18
mm wide

CT-416-820 40 mm in length

CT-416-821 45 mm in length

CT-416-822 50 mm in length

CT-416-823 55 mm in length

CT-416-824 60 mm in length

CT-416-825 65 mm in length

CT-416-826 75 mm in length

CT-416-827 85 mm in length



Caspar Lumbar Speculum

Caspar Counter Retractor

For Caspar Speculum / 60 mm
maximum spread

CT-416-800 complete with 5 blades
CT-416-801 retractor only

Caspar Serrated Lateral Blade

For Counter Retractor

CT-416-802 35 mm
CT-416-803 40 mm
CT-416-804 45 mm
CT-416-805 50 mm
CT-416-806 55 mm
CT-416-807 60 mm
CT-416-808 65 mm
CT-416-809 75 mm
CT-416-810 85 mm



Caspar Speculum &
Counter Retractor

Counter Retractor

Lateral blade

Scoville Retractor Frame

lumbar retractor system / accommodates
all blade types / double articulation / 8
1/4" long with 6 1/2" arms

CT-417-098

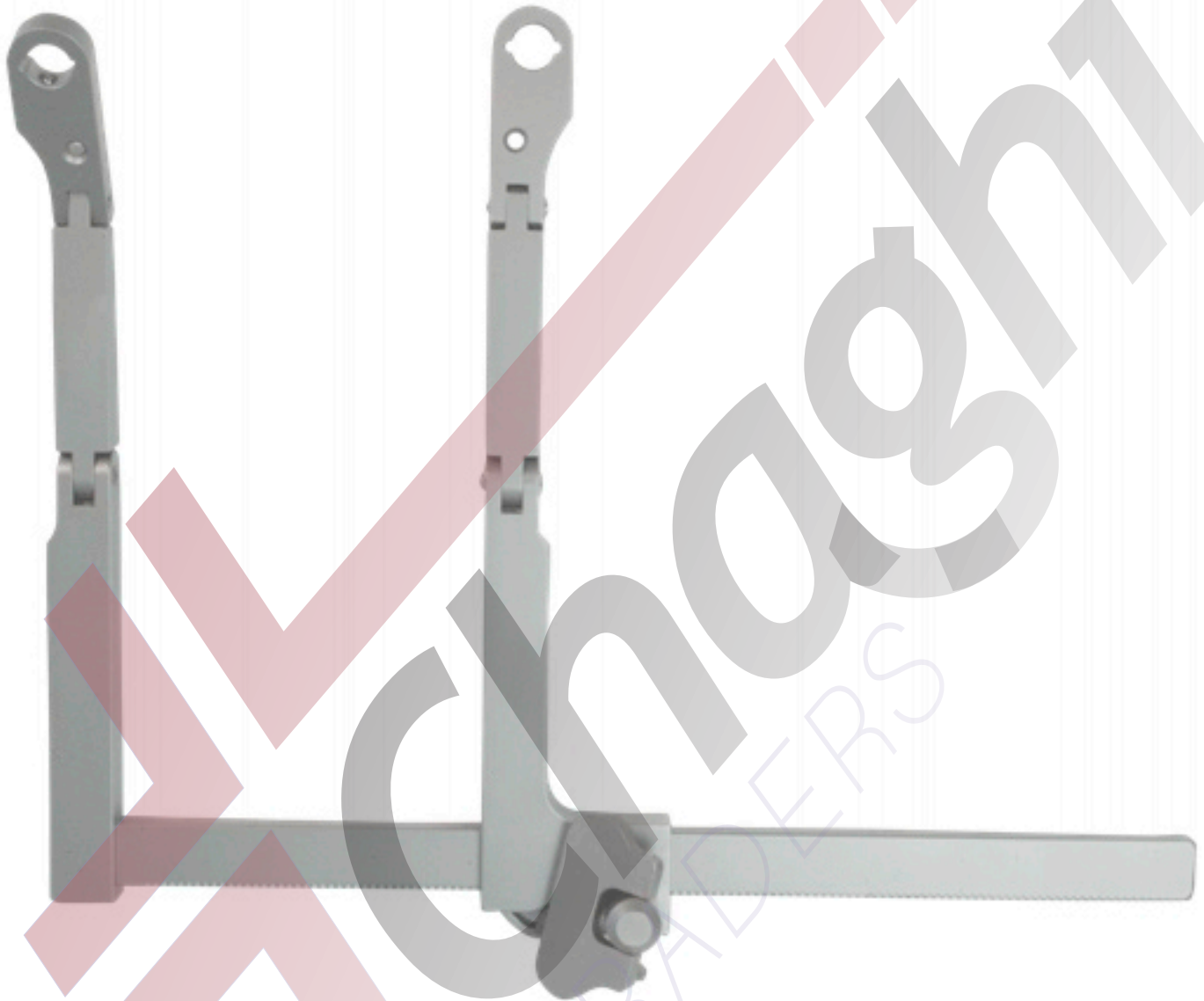

CT-417-098

Scoville Lumbar Blade

23 mm wide

CT-417-0030	23 x 35 mm
CT-417-0031	23 x 45 mm
CT-417-0032	23 x 55 mm
CT-417-0033	23 x 65 mm
CT-417-0034	23 x 75 mm
CT-417-0035	23 x 85 mm
CT-417-0036	23 x 100 mm
CT-417-0037	23 x 120 mm

45 mm wide

CT-417-0050	45 x 50 mm
CT-417-0051	45 x 60 mm
CT-417-0052	45 x 70 mm
CT-417-0053	45 x 80 mm

60 mm wide

CT-417-0060	60 x 50 mm
CT-417-0061	60 x 60 mm
CT-417-0062	60 x 70 mm
CT-417-0063	60 x 80 mm
CT-417-0064	60 x 100 mm
CT-417-0065	60 x 120 mm

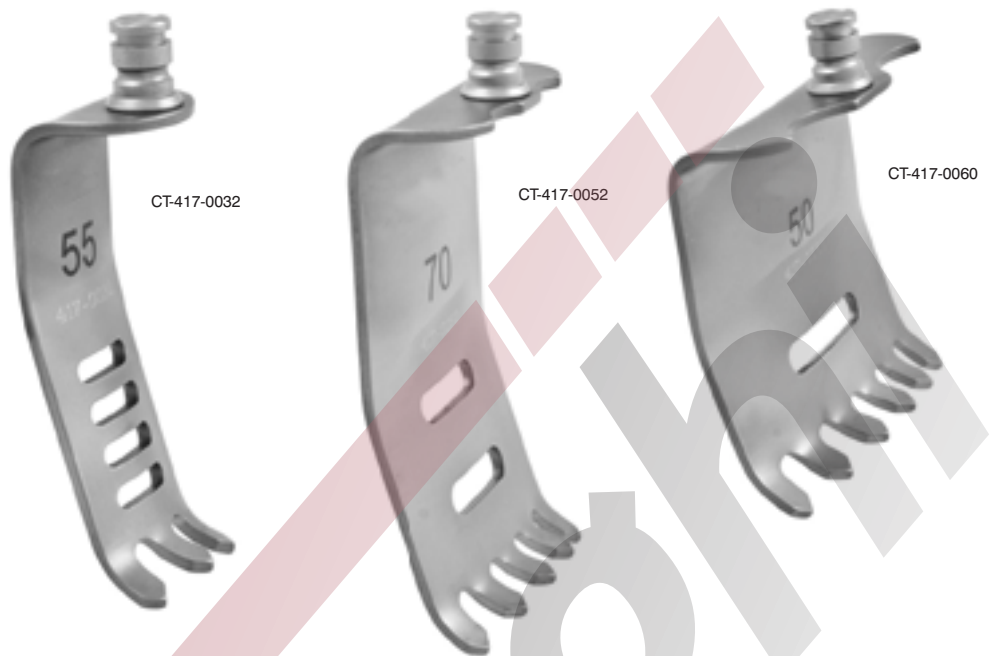

Scoville Middle Lumbar Blade

15 degrees

CT-417-0135	35 mm
CT-417-0136	40 mm
CT-417-0137	45 mm
CT-417-0138	50 mm
CT-417-0139	55 mm
CT-417-0140	60 mm
CT-417-0141	65 mm
CT-417-0142	70 mm
CT-417-0143	75 mm
CT-417-0144	80 mm



Micro Lamina Spreader

With speed lock / many tip widths
available / 5 3/4" (14.5 cm)

CT-417-058

With speed lock / deep angle / 6 3/4"
(17.1 cm)

CT-417-058D



CT-417-058

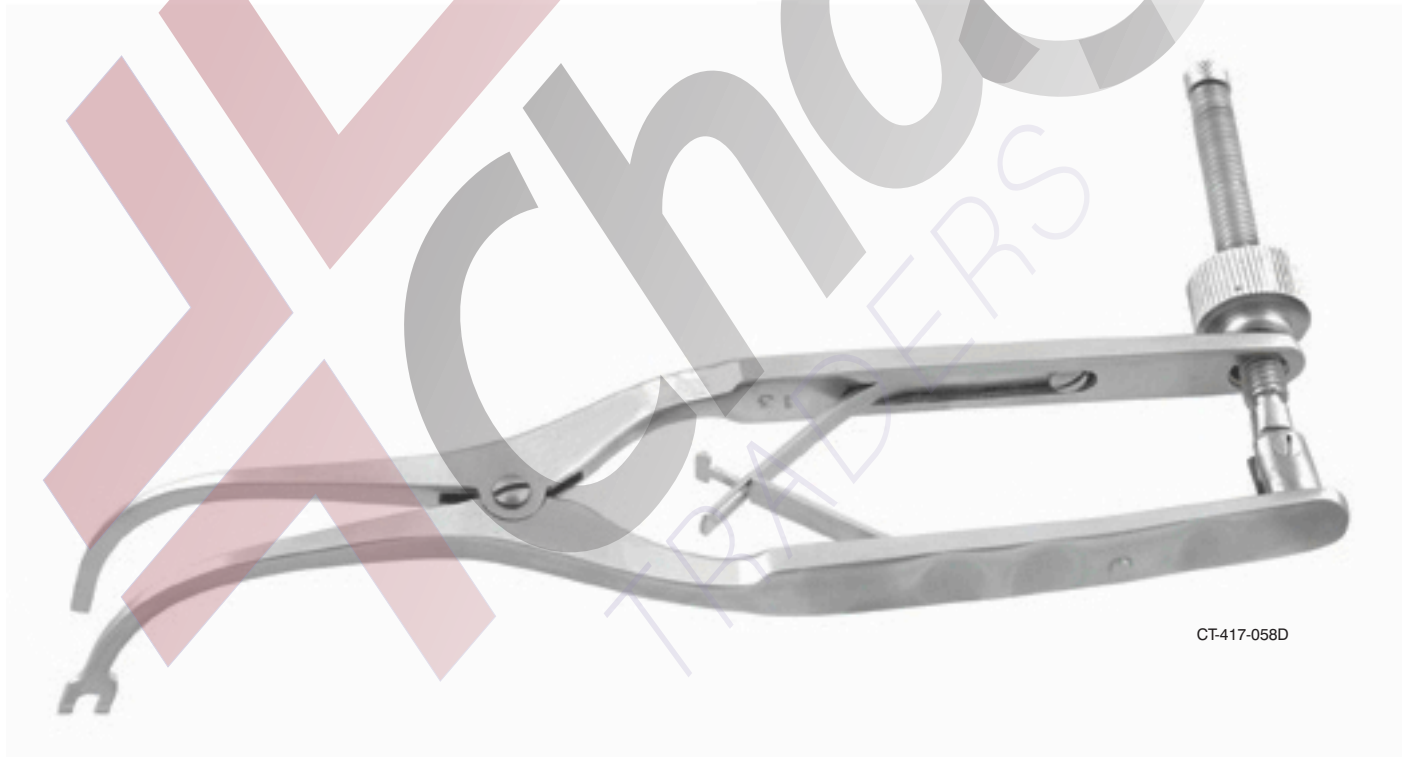

CT-417-058D

Caspar Nerve-Root Retractor

For micro lumbar dissection

- CT-416-844 4 mm
- CT-416-846 6 mm
- CT-416-848 8 mm
- CT-416-850 10 mm



CT-416-844



CT-416-846



CT-416-848



CT-416-850

Cloward Cervical Retractor

64 mm maximum spread

CT-416-130 complete, with 5 toothed blades
CT-416-131 frame only

Blunt Blade

For Cloward Cervical Retractor

CT-416-132 40 mm x 15/23 mm
CT-416-133 45 mm x 15/23 mm
CT-416-134 50 mm x 15/23 mm
CT-416-135 55 mm x 15/23 mm
CT-416-136 60 mm x 15/23 mm



Cloward Cervical Retractor

114 mm maximum spread

CT-416-100 complete, with 5 toothed blades

CT-416-101 frame only

Toothed Blade

For Cloward Cervical Retractor

CT-416-102 40 mm x 15/23 mm

CT-416-103 45 mm x 15/23 mm

CT-416-104 50 mm x 15/23 mm

CT-416-105 55 mm x 15/23 mm

CT-416-106 60 mm x 15/23 mm

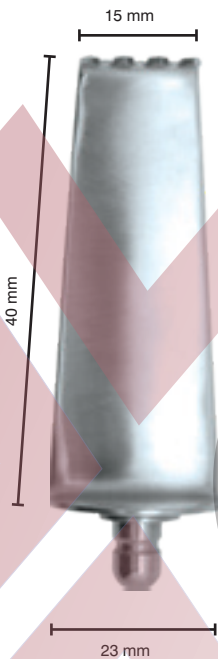

Neuro Caliper

8 3/4" (22 cm)

CT-355-250



CT-355-250

Caspar System Complete Set

1103-729 tray
 CT-416-199 set Call for individual & set pricing

Set includes:

- CT-416-200 caspar cervical vertebral column retractor frame
- CT-416-220 caspar hand retractor with depth gauge 8"
- OR**
- CT-416-220B caspar hand retractor with screw on blade 7 1/4"
- CT-416-230 caspar cervical vertebral retractor "v-shape 4 1/2"
- CT-416-260 caspar cervical vertebral retractor 8" double articulating
- CT-416-280 caspar cervical vertebral retractor 6 1/2" single
- CT-416-299 caspar forceps for changing blades
- CT-416-300 caspar distractor right
- CT-416-305 caspar distractor left
- CT-416-314 screw post for distractor 14 mm
- CT-416-330 caspar screwdriver universal
- CT-416-335 caspar twist drill 1.7mm
- CT-416-340 drill guide 65 degree angle right phenolic handle
- CT-416-342 drill guide 65 degree angle left phenolic handle
- CT-417-058D micro lamina spreader deep angle with speed lock 6 3/4"
 assorted blades (10 sets) different sizes

tray

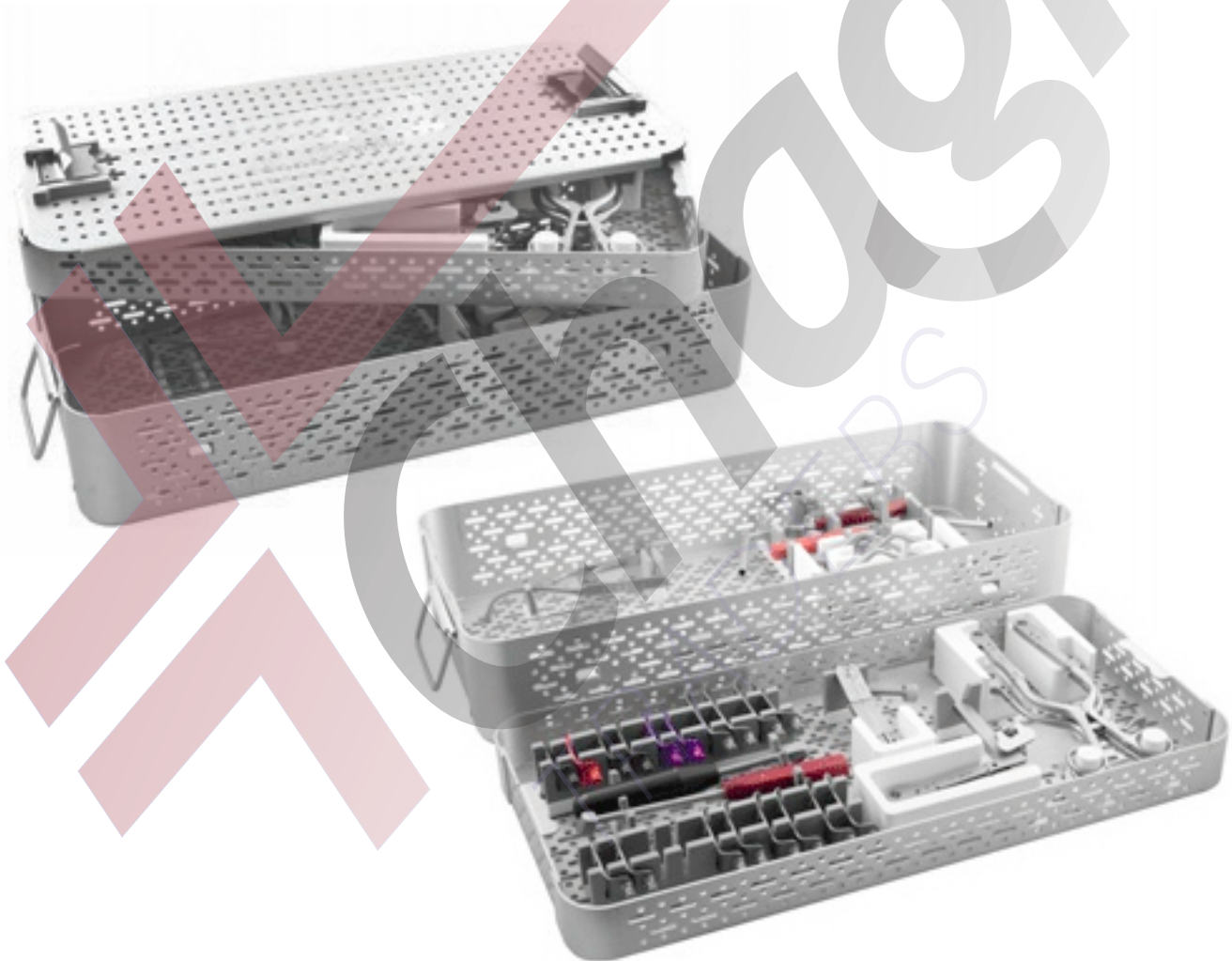



Chaghi

TRADERS



Email : info@chaghitraders.com



Website: www.chaghitraders.com



Mobile & Whatsapp: 0092 333 1277 676



Address: New Miana Pura West, Near Islamic Road, Eid Gah Chowk, Sialkot , 51310, Pakistan.